

WCB

Saldatrici
Carica Batterie



Welding Equipment
Battery Chargers

Poste à Souder
Chargeurs de Batteries

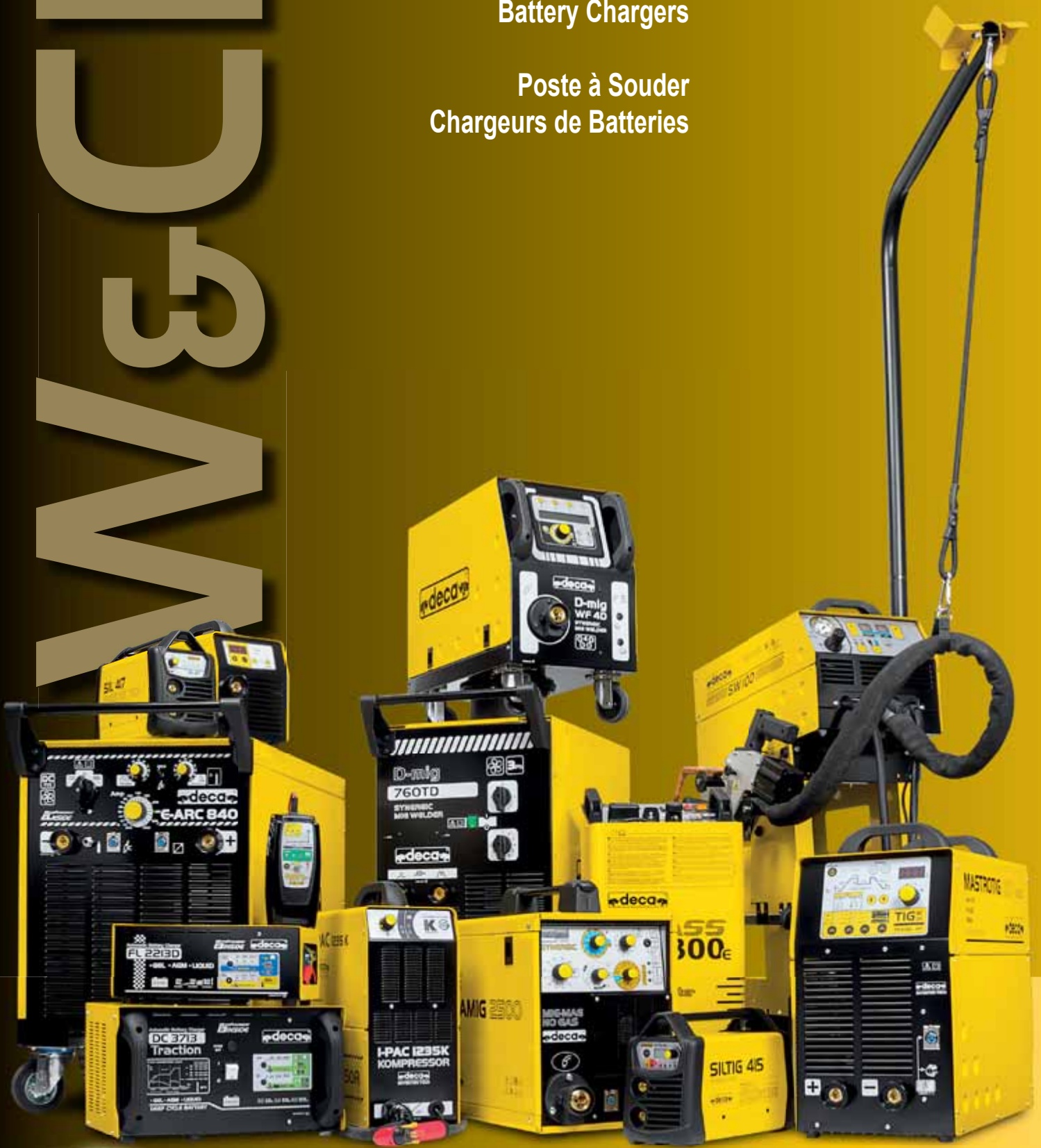

**EUROPEAN
PRODUCT**



2014



Servizio

Noi crediamo nell'importanza del supporto alla vendita attraverso la consulenza e la formazione.

Siamo in grado di offrire tempestivamente il miglior supporto specializzato per prendersi cura per tutta la vita dell'apparecchiatura.

Service

We believe in the importance of the sales support through the advise and training.

We can promptly offer the best and specialized support for taking care throughout the life of the equipment.

Services

Nous croyons en l'importance de l'aide à la vente par le conseiller et de formation. Nous pouvons rapidement offrir le meilleur support et spécialisés pour prendre soin tout au long de la vie de l'équipement.





Qualità ed abilità tecnica

Molti elementi contribuiscono alla qualità intrinseca dei nostri prodotti ma nessuno è più importante degli alti standard di lavorazione e di controllo qualità.

Quality and Workmanship

Many elements contribute to the quality inherent in our equipment but none is more important than the highest standards of workmanship and quality control.

Qualité et savoir-faire

Plusieurs éléments contribuent à la qualité inhérente à notre équipement, mais aucun n'est plus important que les plus hauts standards de fabrication et contrôle qualité.



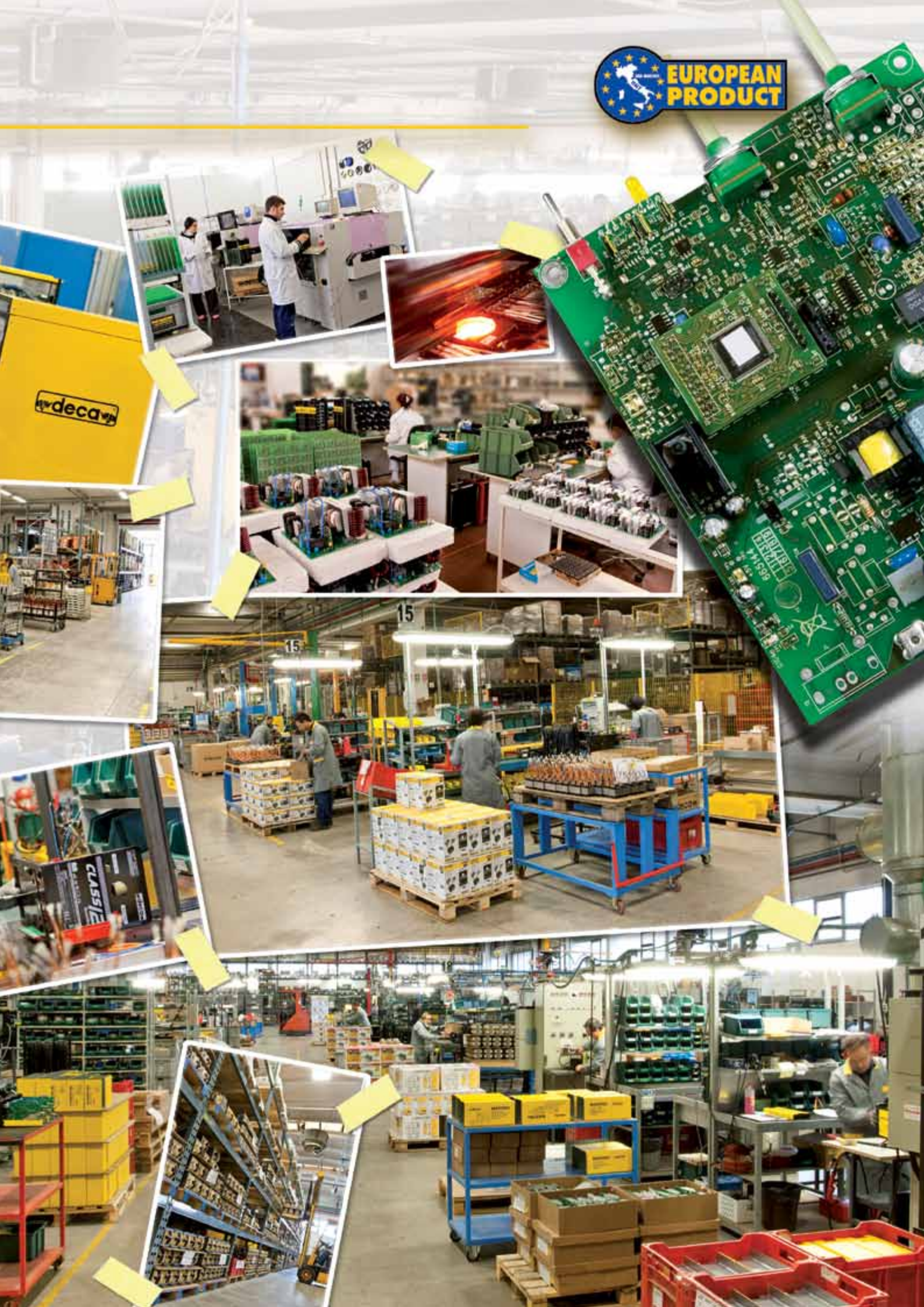



Innovazione

Mentre facciamo tesoro delle nostre tradizioni, è il futuro che ci ispira. L'innovazione è la vera forza propulsiva della società.



Innovation

While we treasure our traditions, it is the future that inspires us. Innovation is the true driving force of the company.



Innovation

Alors que nous chérissons nos traditions, c'est l'avenir qui nous inspire. L'innovation est le véritable moteur de l'entreprise.

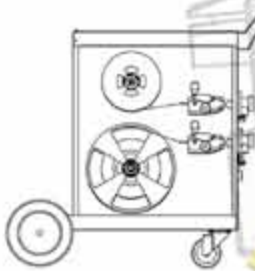

Sicurezza

Tutti i nostri prodotti sono progettati secondo le norme di sicurezza di riferimento e sono costruiti con materiali conformi alla normativa Rohs.

La nostra attenzione è certificata dai più autorevoli enti di certificazione internazionali



Safety

All our products are designed to meet relevant safety standards and are manufactured with RoHS compliant materials.

Our attention has been certified by the most prominent international certification bodies



Sécurité

Tous nos produits sont conçus pour répondre aux normes de sécurité applicables et sont fabriqués avec des matériaux conformes RoHS.

Notre attention a été certifié par les organismes de certification internationaux les plus éminents.



Soluzioni per Saldare

Ad ogni lavoro la soluzione migliore

Welding Solutions

For every job the best solution

Solutions de Soudure

Pour chaque emploi la meilleure solution

 **MMA** Pag. 10

 **TIG** Pag. 28

 **MIG** Pag. 38

 **PAC** Pag. 54

 **SPOT** Pag. 58

 Accessori - Accessories - Accessoires Pag. 87



LIGHT DUTY

- Attrezzature per la manutenzione, i piccoli lavori ed il "Fai da te".
- Equipment for maintenance, small jobs and DIY.
- Équipements pour l'entretien, petits travaux et bricolage.



PROFESSIONAL

- Attrezzature ad alte prestazioni per gli utilizzi professionali.
- High-performance equipment for professional use.
- Équipements de haute performance pour un usage professionnel.



- Attrezzature ideali per il settore carrozzeria e per saldare su bassi spessori.
- Ideal equipment for car body repair and welding of low thickness.
- Idéal équipements pour la réparation de carrosserie et soudure de faible épaisseur.



INDUSTRIAL

- Attrezzature per il settore delle costruzioni e la saldatura pesante.
- Equipment for the construction and heavy welding.
- Équipements pour la construction et le soudage lourds.

Sistemi per la carica delle batterie

Battery charging systems

Systèmes pour la charge des batteries

Pag. 66

INVERTER
MAINTENANCE

ELECTRONIC
FULL POWER

ELECTRONIC
STAR & STOP

TRADITIONAL
PRO CHARGE

MMA





LIGHT DUTY

SIL 208 - 313 - 415 - 417	Pag. 10
TECNO 130E - 165T	Pag. 16
STAR 140E - 190E - 210E - 220E - 270E	Pag. 17
PARVA 140E - 145E - 150E - 165E - 175E	Pag. 18
DOMUS 171E - 175E	Pag. 19



PROFESSIONAL

MOS EVO Series	Pag. 11
MOS 150GEN - 170GEN - 210GEN	Pag. 12
T-ARC 520 - 525	Pag. 20
P-ARC 525 AC/DC	Pag. 23



INDUSTRIAL

MASTRO 32EVO - 40EVO - 50EVO	Pag. 13
MASTRO 314 HD - 416 HD GEN - 518 HD GEN	Pag. 14
MASTRO 627	Pag. 15
T-ARC 527 - 529	Pag. 21
T-ARC 530 - 845	Pag. 22
P-ARC 526 - 735 - 840 - 846	Pag. 24
E-ARC 840 - 860	Pag. 25

Caratteristiche

- **DC:** la corrente erogata è continua, sia diretta che inversa (escluso SIL 208). Consente di saldare con moltissimi tipi di elettrodi svariate qualità di metalli: rutili, basici (escluso SIL 208), inox, ghisa, etc.
- **TIG "Scratch"** con innescò a striscio: è ideale per chiunque necessiti la finezza ed accuratezza di lavoro, ottenibile solo con il processo TIG. I materiali saldabili sono: inox, rame, nichel etc. (escluso SIL 208 - SIL 313)
- **HOT START:** uno spunto di potenza aggiuntiva (booster) facilita l'innescò dell'arco. Molto utile per gli elettrodi di difficile innescò.
- **ANTI-STICKING:** elimina il fastidio dell'incollamento dell'elettrodo al pezzo.
- **ARC FORCE:** aumenta gli ampere quando l'arco di saldatura è tenuto corto.
- **Protezione termostatica, sovratensione, *motogeneratore +/- 15%**

Features

- **DC:** the output current is direct, either electrode positive (DCEP) or electrode negative (DCEN) (except SIL 208). It allows to weld with many types of electrodes and materials: rutile, basic (except SIL 208), stainless steel, cast iron, etc.
- **TIG "Scratch"** with scratch striking it's ideal for anyone who requires the finesse available only from TIG process. You can weld: steel, stainless steel, copper, nickel etc. (except SIL 208 - SIL 313)
- **HOT START:** built-in "hot start" for easy electrode striking. Useful especially for "difficult-to-start" electrodes.
- **ANTI-STICKING:** no electrode sticking.
- **ARC FORCE:** it gives additional amperage during short arc length conditions while welding.
- **Thermostatical protection, overvoltage, *motogenerator +/- 15%**

Caractéristiques

- **DC:** le courant débité est continu, aussi bien direct qu'inverse (sauf SIL 208). Il permet de souder différents types de métaux en utilisant plusieurs types d'électrodes: rutilé, basiques (sauf SIL 208), inox, fonte, etc.
- **TIG "Scratch"** avec amorçage à rayure: Idéal pour qui doit effectuer un travail très fin et soigné: un résultat qui peut être obtenu uniquement au moyen du procédé TIG. Les matériaux qui peuvent être soudés sont les suivants: inox, cuivre, nickel etc. (sauf SIL 208 - SIL 313)
- **HOT START:** une puissance d'admission additionnelle (booster) facilite l'amorçage de l'arc. Très utile pour les électrodes que l'on peut difficilement amorcer.
- **ANTI-STICKING:** élimine l'inconvénient représenté par le collage de l'électrode à la pièce.
- **ARC FORCE:** augmente les ampères lorsque l'arc de soudage est maintenu "court".
- **Protections thermostatique, sourvoltage, *motogenerateur +/- 15%**

1
PHASE

MICRO
PROCESSOR

GENERATOR

TURBO

OPTIONAL

- | | | | |
|---|--|--|--|
| Elettrodo rutilico
Rutile electrodes
Electrode rutile
ø 1,6
010220 (40 pcs)
010224 (100 pcs)
ø 2,0
010221 (40 pcs)
010225 (80 pcs)
ø 2,5
010222 (30 pcs)
010125 (55 pcs)
ø 3,2
010223 (16 pcs)
010126 (30 pcs) | Elettrodo Basico
Basic Electrodes
Electrodes basiques
ø 2,5
010127 (30 pcs) | Acciaio Inox
Stainless Steel
Acier Inox
ø 2,0
010128 (40 pcs)
ø 2,5
010129 (30 pcs) | Ghisa
Cast Iron
Fonte
ø 2,5
010131 (6 pcs)
010130 (16 pcs) |
|---|--|--|--|

Dotazione - Supplied with - Equipés avec

- Kit MMA
- + Valigia
- + Carry Case
- + Valise



Caratteristiche tecniche	Technical specifications	Données techniques		2,2	SIL 208	3,2	SIL 313	4,0	SIL 415	4,0	SIL 417
Alimentazione	Input voltage	Tension d'alimentation	Volt 50-60 Hz		1 Ph x 230		1 Ph x 230		1 Ph x 230		1 Ph x 230
Fusibile di rete	Fuse	Fusible	Amp		10		16		16		16
Potenza d'installazione	Installation power	Puissance d'installation	KW		1,5		2,5		3,0		4,5
Tensione a vuoto	Open circuit voltage	Tension à vide	Volt		85		85		102		102
Elettrodi utilizzabili	Usable electrodes	Elettrodes utilisables	Ø mm		1,6 - 2,5		1,6 - 3,2		1,6 - 4,0		1,6 - 4,0
Campo di regolazione	Welding current range	Champ de réglage	Amp		10 - 80		10 - 130		10 - 150		10 - 170
Servizio	Duty cycle	Facteur de marche	Amp		80 @ 50%		125 @ 60%		150 @ 60%		170 @ 40%
Servizio	Duty cycle	Facteur de marche	Amp		EN 60974-1 40°C		125 @ 7%		140 @ 7%		160 @ 8%
Dimensioni	Dimensions	Dimensions	mm		132 x 293 x 206		132 x 293 x 206		132 x 335 x 206		132 x 335 x 206
Peso	Weight	Poids	≈kg.		2,9		2,6		3,6		3,6

MOS EVO Series

MMA
PROFESSIONAL

INVERTER

Caratteristiche

- **DC:** la corrente erogata è continua, sia diretta che inversa. Consente di saldare con moltissimi tipi di elettrodi svariate qualità di metalli: rutili, basici, inox, ghisa, etc.
- **TIG:** è ideale per chiunque necessiti la finezza ed accuratezza di lavoro, ottenibile solo con il processo TIG. I materiali saldabili sono: inox, rame, nichel etc.
- **HOT START:** uno spunto di potenza aggiuntiva (booster) facilita l'innescio dell'arco. Molto utile per gli elettrodi di difficile innescio.
- **ANTI-STICKING:** elimina il fastidio dell'incollamento dell'elettrodo al pezzo.
- **ARC FORCE:** aumenta gli ampere quando l'arco di saldatura è tenuto corto.
- **Protezione termostatica, sovratensione, *motogeneratore +/- 15%**

Features

- **DC:** the output current is direct, either electrode positive (DCEP) or electrode negative (DCEN). It allows to weld with many types of electrodes and materials: rutile, basic, stainless steel, cast iron, etc.
- **TIG** It's ideal for anyone who requires the finesse available only from TIG process. You can weld: steel, stainless steel, copper, nickel etc.
- **HOT START:** built-in "hot start" for easy electrode striking. Useful especially for "difficult-to-start" electrodes.
- **ANTI-STICKING:** no electrode sticking.
- **ARC FORCE:** it gives additional amperage during short arc length conditions while welding.
- **Thermostatical protection, overvoltage, *motogenerator +/- 15%**

Caractéristiques

- **DC:** le courant débité est continu, aussi bien direct qu'inverse. Il permet de souder différents types de métaux en utilisant plusieurs types d'électrodes: rutilé, basiques, inox, fonte, etc.
- **TIG:** Idéal pour qui doit effectuer un travail très fin et soigné: un résultat qui peut être obtenu uniquement au moyen du procédé TIG. Les matériaux qui peuvent être soudés sont les suivants: inox, cuivre, nickel etc.
- **HOT START:** une puissance d'admission additionnelle (booster) facilite l'amorçage de l'arc. Très utile pour les électrodes que l'on peut difficilement amorcer.
- **ANTI-STICKING:** élimine l'inconvénient représenté par le collage de l'électrode à la pièce.
- **ARC FORCE:** augmente les ampères lorsque l'arc de soudage est maintenu "court".
- **Protections thermostatique, sourvoltage, *motogenerateur +/- 15%**



1
PHASE



OPTIONAL

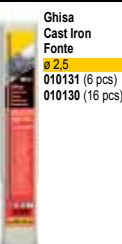
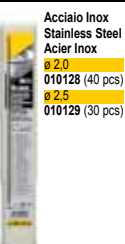
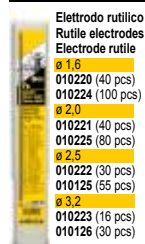

KIT MMA - DS 10



000200

KIT TIG-TG9



000197

Disponibili in 2 versioni
Available in 2 versions
Disponible en 2 versions

1

Kit MMA
+ Valigia
+ Carry Case
+ Valise



2

Fornita senza accessori
Supplied without accessories
Equipés sans accessoires

Caratteristiche tecniche	Technical specifications	Données techniques		MOS 138EVO	MOS 168EVO
Alimentazione	Input voltage	Tension d'alimentation	Volt 50-60 Hz	1 Ph x 230	1 Ph x 230
Fusibile di rete	Fuse	Fusible	Amp	16	16
Potenza d'installazione	Installation power	Puissance d'installation	KW	2,5	3,0
Tensione a vuoto	Open circuit voltage	Tension à vide	Volt	75	75
Elettrodi utilizzabili	Usable electrodes	Elettrodes utilisables	Ø mm	1,6 - 3,2	1,6 - 4,0
Campo di regolazione	Welding current range	Champ de réglage	Amp	5 - 130	5 - 150
Servizio	Duty cycle	Facteur de marche	Amp		
			DECA use at 20°C	115 @ 75%	150 @ 48%
Servizio	Duty cycle	Facteur de marche	Amp		
			EN 60974-1 40°C	130 @ 20%	150 @ 20%
Dimensioni	Dimensions	Dimensions	mm	275 x 130 x 170	320 x 130 x 170
Peso	Weight	Poids	≈kg.	3,5	4,0



MOSGEN Series

MMA
PROFESSIONAL

INVERTER

Caratteristiche

- **DC:** la corrente erogata è continua, sia diretta che inversa. Consente di saldare con moltissimi tipi di elettrodi svariate qualità di metalli: rutili, basici, inox, ghisa, etc.
- **TIG:** è ideale per chiunque necessiti la finezza ed accuratezza di lavoro, ottenibile solo con il processo TIG. I materiali saldabili sono: inox, rame, nichel etc.
- **HOT START:** uno spunto di potenza aggiuntiva (booster) facilita l'innescio dell'arco. Molto utile per gli elettrodi di difficile innescio.
- **ANTI-STICKING:** elimina il fastidio dell'incollamento dell'elettrodo al pezzo.
- **ARC FORCE:** aumenta gli ampere quando l'arco di saldatura è tenuto corto.
- **Protezione termostatica, sovratensione.**

Features

- **DC:** the output current is direct, either electrode positive (DCEP) or electrode negative (DCEN). It allows to weld with many types of electrodes and materials: rutile, basic, stainless steel, cast iron, etc.
- **TIG** It's ideal for anyone who requires the finesse available only from TIG process. You can weld: steel, stainless steel, copper, nickel etc.
- **HOT START:** built-in "hot start" for easy electrode striking. Useful especially for "difficult-to-start" electrodes.
- **ANTI-STICKING:** no electrode sticking.
- **ARC FORCE:** it gives additional amperage during short arc length conditions while welding.
- **Thermostatical protection, overvoltage.**

Caractéristiques

- **DC:** le courant débité est continu, aussi bien direct qu'inverse. Il permet de souder différents types de métaux en utilisant plusieurs types d'électrodes: rutile, basiques, inox, fonte, etc.
- **TIG:** Idéal pour qui doit effectuer un travail très fin et soigné: un résultat qui peut être obtenu uniquement au moyen du procédé TIG. Les matériaux qui peuvent être soudés sont les suivants: inox, cuivre, nickel etc.
- **HOT START:** une puissance d'admission additionnelle (booster) facilite l'amorçage de l'arc. Très utile pour les électrodes que l'on peut difficilement amorcer.
- **ANTI-STICKING:** élimine l'inconvénient représenté par le collage de l'électrode à la pièce.
- **ARC FORCE:** augmente les ampères lorsque l'arc de soudage è maintenu "court".
- **Protections thermostatique, sourvoltage.**



1
PHASE



GENERATOR



TURBO

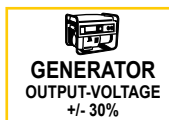

Disponibili in 2 versioni
Available in 2 versions
Disponible en 2 versions

1

Kit MMA
+ Valigia
+ Carry Case
+ Valise



2

Fornita senza accessori
Supplied without accessories
Equipés sans accessoires



OPTIONAL

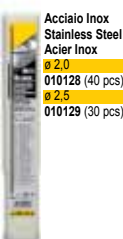
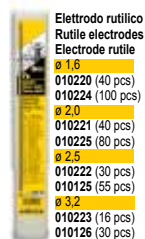

MOS 150 - 170 GEN ✓
MOS 210 GEN ✓



Caratteristiche tecniche	Technical specifications	Données techniques		MOS 150GEN	MOS 170GEN	MOS 210GEN
Alimentazione	Input voltage	Tension d'alimentation	Volt 50-60 Hz	1 Ph x 230	1 Ph x 230	1 Ph x 230
Fusibile di rete	Fuse	Fusible	Amp	16	16	16
Potenza d'installazione	Installation power	Puissance d'installation	KW	3,0	3,5	4,5
Tensione a vuoto	Open circuit voltage	Tension à vide	Volt	75	75	75
Campo di regolazione	Welding current range	Champ de réglage	Amp	5 - 140	5 - 160	5 - 165
Elettrodi utilizzabili	Usable electrodes	Elettrodes utilisables	Ø mm	1,6 - 3,2	1,6 - 4,0	1,6 - 4,0
Servizio	Duty cycle	Facteur de marche	Amp	140 @ 35% 100 @ 60%	160 @ 20% 115 @ 60%	165 @ 20% 120 @ 60%
Dimensioni	Dimensions	Dimensions	mm	320 x 130 x 170		
Peso	Weight	Poids	≈kg.	4,0	4,0	4,0



MASTRO^{evo} Series

MMA
INDUSTRIAL

INVERTER

DC
-+

1
PHASE

CELLULOSIC

TIG
LIFT

MICRO
PROCESSOR

GENERATOR

TURBO

CE

PG

Saldatura MMA in corrente continua DC

- Consente di saldare con moltissimi tipi di elettrodi svariate qualità di metalli: cellulostici, rutili, basici, inox, ghisa, etc.
- **HOT START**. Facilita l'innesco dell'arco di saldatura con elettrodi particolarmente difficili.
- **ANTI-STICKING**. Evita l'incolatura dell'elettrodo al pezzo.
- **ARC FORCE** regolabile. Permette di controllare la penetrazione della saldatura e migliora la stabilità d'arco.

Saldatura TIG

- **TIG**. E' in grado di saldare piccoli spessori di diversi materiali, quali: acciaio, acciaio inox, rame, nichel, ecc. utilizzando l'apposito Kit e la protezione di gas Argon.
- **TIG LIFT**. Permette l'innesco dell'arco senza deteriorare l'elettrodo di tungsteno.
- **Protezione termostatica, sovratensione.**

MMA welding in direct current DC

- It allows to weld with many types of electrodes and materials: cellulosic, rutile, basic, stainless steel, cast iron, etc.
- **HOT START**. Built-in "hot start" for easy electrode striking. Useful especially for "difficult-to-start" electrodes.
- **ANTI-STICKING**. No electrode sticking.
- **ARC FORCE** adjustable. Enables to control the welding penetration and improve the arc stability.

TIG WELDING

- **TIG**. By using the proper TIG welding kit and pure argon gas, the machine is able to weld thin metal sheets of many type of materials as: mild steel, stainless steel, copper, nickel etc.
- **TIG LIFT**. Optimise the arc stroke, improving the life of the electrode avoiding tungsten inclusions in the weld puddle.
- **Thermostatical protection, overvoltage.**

Soudure MMA en courant continu DC

- Il permet de souder différents types de métaux en utilisant plusieurs types d'électrodes: cellulostique, rutilés, basiques, inox, fonte, etc.
- **HOT START**. Très utile pour les électrodes que l'on peut difficilement amorcer
- **ANTI-STICKING**. Élimine le collage de l'électrode à la pièce.
- **ARC FORCE** réglable. Permet de régler la pénétration de soudage et optimise la stabilité de l'arc de soudage.

Soudure TIG

- **TIG**. Idéal pour la soudure de très petites épaisseurs de matériaux suivants: inox, cuivre, nickel etc. en utilisant le kit approprié et la protection du gaz Argon.
- **TIG LIFT**. Pour l'amorçage de l'arc dans le système TIG avec un courant bas afin de ne pas coller l'électrode à la pièce facilite l'amorçage de l'arc et évite le détérioration de l'électrode.
- **Protections thermostatique, sourvoltage.**



GENERATOR
OUTPUT-VOLTAGE
+/- 30%

OPTIONAL



Disponibili in 2 versioni
Available in 2 versions
Disponible en 2 versions

1

Kit MMA
+ Valigia
+ Carry Case
+ Valise



2

Fornita senza accessori
Supplied without accessories
Équipés sans accessoires

Caratteristiche tecniche	Technical specifications	Données techniques		3,2 MASTRO 32EVO		4,0 MASTRO 40EVO		5,0 MASTRO 50EVO	
				TIG	MMA	TIG	MMA	TIG	MMA
Alimentazione	Input voltage	Tension d'alimentation	Volt 50-60 Hz	1 Ph x 230		1 Ph x 230		1 Ph x 230	
Fusibile di rete	Fuse	Fusible	Amp	25		25		25	
Potenza d'installazione	Installation power	Puissance d'installation	KW	4,3		5,0		5,7	
Tensione a vuoto	Open circuit voltage	Tension à vide	Volt	80		80		80	
Campo di regolazione	Welding current range	Champ de réglage	Amp	5 - 160	30 - 140	5 - 180	30 - 165	5 - 200	30 - 180
Elettrodi utilizzabili	Usable electrodes	Elettrodes utilisables	Ø mm	1 - 3,2	1,6 - 3,2	1 - 3,2	1,6 - 4	1 - 3,2	1,6 - 5
Servizio	Duty cycle	Facteur de marche	Amp	160 @ 40%	140 @ 40%	180 @ 40%	165 @ 40%	200 @ 40%	180 @ 40%
				130 @ 60%	115 @ 60%	150 @ 60%	135 @ 60%	165 @ 60%	145 @ 60%
Dimensioni	Dimensions	Dimensions	mm	400 x 160 x 260					
Peso	Weight	Poids	≈kg.	6,8		6,8		6,8	

MASTRO HD Series



INDUSTRIAL

INVERTER

Saldatura MMA in corrente continua DC

- Consente di saldare con moltissimi tipi di elettrodi svariate qualità di metalli: rutili, basici, inox, ghisa, etc.
- **HOT START** regolabile.
- **ANTI-STICKING**.
- **ARC FORCE** regolabile.

Saldatura TIG

- **TIG.** E' in grado di saldare piccoli spessori di diversi materiali, quali: acciaio, acciaio inox, rame, nichel, ecc. utilizzando l'apposito Kit e la protezione di gas Argon.
- **TIG LIFT.** Permette l'innescio dell'arco senza deteriorare l'elettrodo di tungsteno.
- **SLOPE DOWN** regolabile.
- **Protezione termostatica, sovratensione, motogeneratore +/- 15%** (MASTRO 314)

MMA welding in direct current DC

- It allows to weld with many types of electrodes and materials: rutile, basic, stainless steel, cast iron, etc.
- **HOT START** adjustable.
- **ANTI - STICKING**.
- **ARC FORCE** adjustable.

TIG WELDING

- **TIG.** The machine is able to weld thin metal sheets of many type of materials as: mild steel, stainless steel, copper, nickel etc.
- **TIG LIFT.** Optimise the arc stroke, improving the life of the electrode avoiding tungsten inclusions in the weld puddle.
- **SLOPE DOWN** adjustable.
- **Thermostatical protection, overvoltage, motogenerator +/- 15%** (MASTRO 314)

Soudure MMA en courant continu DC

- Il permet de souder différents types de métaux en utilisant plusieurs types d'électrodes: rutilés, basiques, inox, fonte, etc.
- **HOT START** réglable.
- **ANTI-STICKING**.
- **ARC FORCE** réglable.

Soudure TIG

- **TIG.** Idéal pour la soudure de très petites épaisseurs de matériaux suivants: inox, cuivre, nickel etc. en utilisant le kit approprié et la protection du gaz Argon.
- **TIG LIFT.** Pour l'amorçage de l'arc dans le système TIG avec un courant bas afin de ne pas coller l'électrode à la pièce facilite l'amorçage de l'arc et évite la détérioration de l'électrode.
- **SLOPE DOWN** réglable.
- **Protections thermostatique, sourvoltage, motogénérateur +/- 15%** (MASTRO 314)



1 PHASE

TIG LIFT

MICRO PROCESSOR



GENERATOR



TURBO

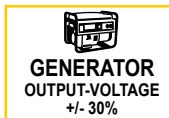

GENERATOR OUTPUT-VOLTAGE +/- 30%

MASTRO 416
MASTRO 518

Disponibili in 2 versioni
Available in 2 versions
Disponible en 2 versions



- 1 Kit MMA + Valigia + Carry Case + Valise
- 2 Fornita senza accessori
Supplied without accessories
Équipés sans accessoires

OPTIONAL



Caratteristiche tecniche	Technical specifications	Données techniques		3,2 MASTRO 314 HD		4,0 MASTRO 416 HD GEN		5,0 MASTRO 518 HD GEN	
				TIG	MMA	TIG	MMA	TIG	MMA
Alimentazione	Input voltage	Tension d'alimentation	Volt 50-60 Hz	1 Ph x 230		1 Ph x 230		1 Ph x 230	
Fusibile di rete	Fuse	Fusible	Amp	20		25		25	
Potenza d'installazione	Installation power	Puissance d'installation	KW	4,3		5		5,7	
Tensione a vuoto	Open circuit voltage	Tension à vide	Volt	100		90		90	
Campo di regolazione	Welding current range	Champ de réglage	Amp	10 - 150	20 - 140	10 - 180	20 - 165	10 - 200	20 - 180
Elettrodi utilizzabili	Usable electrodes	Elettrodes utilisables	Ø mm	1 - 3,2	1,6 - 3,2	1 - 3,2	1,6 - 4	1 - 3,2	1,6 - 5
Servizio	Duty cycle	Facteur de marche	Amp	150 @ 30%	140 @ 35%	180 @ 35%	165 @ 40%	200 @ 30%	180 @ 35%
				110 @ 60%	105 @ 60%	150 @ 60%	140 @ 60%	150 @ 60%	140 @ 60%
Dimensioni	Dimensions	Dimensions	mm	370 x 170 x 270					
Peso	Weight	Poids	=kg.	6,4		6,4		6,4	

MASTRO 627

MMA
INDUSTRIAL

INVERTER

Saldatura MMA in corrente continua DC

- Consente di saldare con moltissimi tipi di elettrodi svariate qualità di metalli: cellulosici, rutili, basici, inox, ghisa, etc.
- **HOT START** regolabile.
- **ARC FORCE** regolabile.
- **ANTI-STICKING**.

Saldatura TIG DC

- **DC**: corrente continua per saldare acciaio ed inox, titanio, rame, bronzo, nichel, ottone.
- Innesco **TIG LIFT**: saldatura TIG con innesco LIFT ARC.
- **SLOPE-UP** regolabile: Regolazione del tempo con cui la corrente di saldatura si porta dal valore iniziale (innesco dell'arco) al valore principale "I (Amp)".
- **SLOPE-DOWN** regolabile: Tempo con cui, dopo il rilascio del pulsante torcia, la corrente di saldatura si porta dal valore principale al valore finale (termine della saldatura).
- **POSTGAS** regolabile: Regolazione del tempo di post-gas.
- **2T** (manuale) - **4T** (automatico)

MMA welding in direct current DC

- It allows to weld with many types of electrodes and materials: cellulosic, rutile, basic, stainless steel, cast iron, etc.
- **HOT START** adjustable.
- **ARC FORCE** adjustable.
- **ANTI - STICKING**.

DC TIG welding

- **DC**: direct current to weld steel, stainless steel, titanium, copper, bronze, nickel.
- **TIG LIFT** striking: TIG welding with LIFT ARC striking.
- **SLOPE-UP** adjustable: Adjustment of time at which the welding current is brought from the initial value (arc start) to the main value "I (Amp)".
- **SLOPE-DOWN** adjustable: Time at which, once the torch button is released, the welding current is brought from the main value to the final value (end of welding).
- **POSTGAS** adjustable: Post-gas time adjustment.
- **2T** (manual) - **4T** (automatic).

Soudure MMA en courant continu DC

- Il permet de souder différents types de métaux en utilisant plusieurs types d'électrodes: cellulosique, rutilles, basiques, inox, fonte, etc.
- **HOT START** réglable.
- **ARC FORCE** réglable.
- **ANTI-STICKING**.

Soudure TIG DC

- **DC**: courant continu pour souder acier, acier inox, titanium, cuivre, bronze, nickel.
- **Amorçage TIG LIFT**: soudage TIG avec amorçage LIFT ARC.
- **SLOPE-UP** réglable: Réglage du temps qu'emploie le courant de soudage pour passer de la valeur initiale (amorçage de l'arc) à la valeur principale "I (Amp)".
- **SLOPE-DOWN** réglable: Temps qu'emploie le courant de soudage pour passer de la valeur principale à la valeur finale (fin du soudage) après le relâchement du bouton de la torche.
- **POSTGAS** réglable: Réglage du temps de post-gaz.
- **2T** (manuel) - **4T** (automatique).



DC
-+

3
PHASE

CELLULOSIC

TIG
LIFT

MICRO
PROCESSOR

TURBO

CE

PG

Dotazione - Supplied with - Equipés avec

Fornita senza accessori
Supplied without accessories
Equipés sans accessoires

OPTIONAL



Caratteristiche tecniche	Technical specifications	Données techniques	MASTRO 627		
Alimentazione	Input voltage	Tension d'alimentation	6,0 3 Ph x 400		
Fusibile di rete	Fuse	Fusible	16		
Potenza d'installazione	Installation power	Puissance d'installation	10		
Tensione a vuoto	Open circuit voltage	Tension à vide	105		
Campo di regolazione	Welding current range	Champ de réglage	Amp	TIG	MMA
				5 - 270	20 - 270
Elettrodi utilizzabili	Usable electrodes	Elettrodes utilisables	Ø mm	1 - 4,0	1,6 - 6,0
Servizio	Duty cycle	Facteur de marche	Amp	270 @ 40%	270 @ 40%
				215 @ 60%	215 @ 60%
Dimensioni	Dimensions	Dimensions	mm	550 x 250 x 490	
Peso	Weight	Poids	≈kg.	30	



Accessori - Accessories - Accessoires MMA Pag. 90 - TIG Pag. 94

TECNO Series

MMA
LIGHT DUTY
TRADITIONAL

Caratteristiche

- **AC:** la corrente erogata è alternata.
Consente di saldare elettrodi rutili, inox, etc.
- Regolazione continua della corrente di saldatura
- Protezione termostatica

Features

- **AC:** the output current is alternating.
It allows to weld rutile, stainless steel, etc. electrodes.
- Continuous setting of welding current
- Overload protection

Caractéristiques

- **AC:** le courant débité est alterné.
Il permet de souder électrodes rutilles, inox, etc.
- Régulation continue du courant de soudure
- Protection thermostatique



1
PHASE



TURBO



OPTIONAL

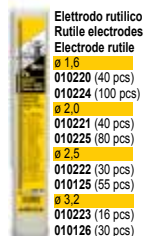

Dotazione - Supplied with - Equipés avec



Caratteristiche tecniche	Technical specifications	Données techniques		TECNO 130E	TECNO 165T
Alimentazione	Input voltage	Tension d'alimentation	Volt 50-60 Hz	1 Ph x 230	1 Ph x 230
Fusibile di rete	Fuse	Fusible	Amp	16	16
Potenza d'installazione	Installation power	Puissance d'installation	KW	1,5 - 3	2 - 4
Tensione a vuoto	Open circuit voltage	Tension à vide	Volt	43 - 48	44 - 48
Campo di regolazione	Welding current range	Champ de réglage	Amp	30 - 100	40 - 140
Elettrodi utilizzabili	Usable electrodes	Elettrodes utilisables	Ø mm	1,6 - 2,5	1,6 - 3,2
Dimensioni	Dimensions	Dimensions	mm	360 x 160 x 290	
Peso	Weight	Poids	≈kg.	12,0	13,7

STAR Series

MMA

LIGHT DUTY

TRADITIONAL

Caratteristiche

- AC: la corrente erogata è alternata. Consente di saldare elettrodi rutili, inox, etc.
- Regolazione continua della corrente di saldatura
- Protezione termostatica

Features

- AC: the output current is alternating. It allows to weld rutile, stainless steel, etc. electrodes.
- Continuous setting of welding current
- Overload protection

Caractéristiques

- AC: le courant débité est alterné. Il permet de souder électrodes rutilles, inox, etc.
- Régulation continue du courant de soudure
- Protection thermostatique



(STAR 220E)



(STAR 210E)



1 PHASE



OPTIONAL

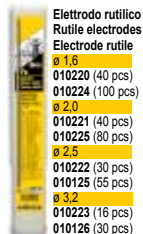

STAR 140-190-210



Dotazione - Supplied with - Equipés avec

	STAR 140-190-210-220	STAR 270
✓	✓	-
-	-	✓
160A	160A	200A
160A	200A	200A

Caratteristiche tecniche	Technical specifications	Données techniques		2,5 STAR 140E	3,2 STAR 190E	4,0 STAR 210E	4,0 STAR 220E	5,0 STAR 270E
Alimentazione	Input voltage	Tension d'alimentation	Volt 50-60 Hz	1 Ph x 230	1 Ph x 230	1 Ph x 230	1 Ph x 230/400	1 Ph x 230/400
Fusibile di rete	Fuse	Fusibile	Amp	16	16	16	16	25/16
Potenza d'installazione	Installation power	Puissance d'installation	KW	1,5 - 3	2 - 4	2 - 5	2 - 5	2 - 6
Tensione a vuoto	Open circuit voltage	Tension à vide	Volt	43 - 48	43 - 48	43 - 48	45 - 48	43,5 - 49
Campo di regolazione	Welding current range	Champ de réglage	Amp	30 - 100	40 - 140	40 - 160	40 - 160	30 - 200
Elettrodi utilizzabili	Usable electrodes	Elettrodes utilisables	Ø mm	1,6 - 2,5	1,6 - 3,2	1,6 - 4,0	1,6 - 4,0	1,6 - 5,0
Dimensioni	Dimensions	Dimensions	mm	390 x 210 x 280			440 x 260 x 310	
Peso	Weight	Poids	=kg.	13,2	15,0	17,0	18,0	21,0



PARVA Series

MMA
LIGHT DUTY
TRADITIONAL

Caratteristiche

- AC: la corrente erogata è alternata.
Consente di saldare elettrodi rutili, inox, etc.
- Regolazione continua della corrente di saldatura
- Protezione termostatica

Features

- AC: the output current is alternating.
It allows to weld rutile, stainless steel, etc, electrodes.
- Continuous setting of welding current
- Overload protection

Caractéristiques

- AC: le courant débité est alterné.
Il permet de souder électrodes rutilles, inox, etc.
- Régulation continue du courant de soudure
- Protection thermostatique



1
PHASE



(PARVA 150E)
(PARVA 165E)

OPTIONAL

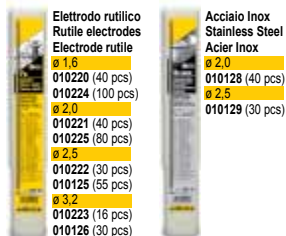

Dotazione - Supplied with - Equipés avec

Model	✓	✓	✓	✓
PARVA 140E	✓	✓	✓	✓
PARVA 145E	✓	✓	✓	✓
PARVA 150E	✓	✓	✓	✓
PARVA 165E	✓	✓	✓	✓
PARVA 175E	-	-	-	-



Caratteristiche tecniche	Technical specifications	Données techniques		2,5 PARVA 140E	3,2 PARVA 145E	4,0 PARVA 150E	4,0 PARVA 165E	4,0 PARVA 175E
Alimentazione	Input voltage	Tension d'alimentation	Volt 50-60 Hz	1 Ph x 230	1 Ph x 230	1 Ph x 230	1 Ph x 230	1 Ph x 230/400
Fusibile di rete	Fuse	Fusible	Amp	16	16	16	16	16
Potenza d'installazione	Installation power	Puissance d'installation	KW	1,5 - 3	2 - 4	2 - 4	2 - 5	2 - 5
Tensione a vuoto	Open circuit voltage	Tension à vide	Volt	43 - 48	44 - 48	44 - 48	44 - 48	45 - 48
Campo di regolazione	Welding current range	Champ de réglage	Amp	30 - 100	40 - 140	40 - 140	40 - 160	40 - 160
Elettrodi utilizzabili	Usable electrodes	Elettrodes utilisables	Ø mm	1,6 - 2,5	1,6 - 3,2	1,6 - 3,2	1,6 - 4,0	1,6 - 4,0
Dimensioni	Dimensions	Dimensions	mm	390 x 210 x 280			440 x 260 x 310	
Peso	Weight	Poids	≈kg.	13,2	14,5	18,0	16,0	18,0



DOMUS Series



MMA
LIGHT DUTY

TRADITIONAL

Caratteristiche

- AC: la corrente erogata è alternata.
Consente di saldare elettrodi rutili, inox, etc.
- Regolazione continua della corrente di saldatura
- Protezione termostatica

Features

- AC: the output current is alternating.
It allows to weld rutile, stainless steel, etc. electrodes.
- Continuous setting of welding current
- Overload protection

Caractéristiques

- AC: le courant débité est alterné.
Il permet de souder électrodes rutilés, inox, etc.
- Régulation continue du courant de soudure
- Protection thermostatique



1
PHASE



OPTIONAL

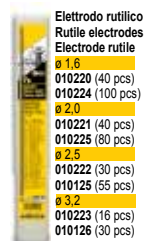

DOMUS 175

KIT MMA - AD 10



000199

Dotazione - Supplied with - Equipés avec

	✓	✓	✓	✓
DOMUS 171	✓	✓	✓	✓
DOMUS 175	-	-	-	-

160A

160A

Caratteristiche tecniche	Technical specifications	Données techniques		DOMUS 171E	DOMUS 175E
Alimentazione	Input voltage	Tension d'alimentation	Volt 50-60 Hz	1 Ph x 230	1 Ph x 230/400
Fusibile di rete	Fuse	Fusible	Amp	16	16
Potenza d'installazione	Installation power	Puissance d'installation	KW	2 - 5	2 - 5
Tensione a vuoto	Open circuit voltage	Tension à vide	Volt	43 - 47	45 - 48
Campo di regolazione	Welding current range	Champ de réglage	Amp	40 - 160	40 - 160
Elettrodi utilizzabili	Usable electrodes	Elettrodes utilisables	Ø mm	1,6 - 4,0	1,6 - 4,0
Dimensioni	Dimensions	Dimensions	mm	610 x 320 x 400	610 x 320 x 400
Peso	Weight	Poids	≈kg.	19,5	19,5



T-ARC Series

MMA
PROFESSIONAL
TRADITIONAL

Caratteristiche

- **AC:** la corrente erogata è alternata. Consente di saldare elettrodi rutili, inox, etc.
- Regolazione continua della corrente di saldatura
- Protezione termostatica

Features

- **AC:** the output current is alternating. It allows to weld rutile, stainless steel, etc. electrodes.
- Continuous setting of welding current
- Overload protection

Caractéristiques

- **AC:** le courant débité est alterné. Il permet de souder électrodes rutilles, inox, etc.
- Régulation continue du courant de soudure
- Protection thermostatique



1
PHASE



OPTIONAL

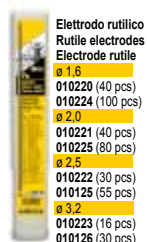

Elettrodo rutilico
Rutile electrodes
Electrode rutile

Ø 1,6
010220 (40 pcs)
010224 (100 pcs)
Ø 2,0
010221 (40 pcs)
010225 (80 pcs)
Ø 2,5
010222 (30 pcs)
010125 (55 pcs)
Ø 3,2
010223 (16 pcs)
010126 (30 pcs)



Acciaio Inox
Stainless Steel
Acier Inox

Ø 2,0
010128 (40 pcs)
Ø 2,5
010129 (30 pcs)

T-ARC 520



T-ARC 525



Dotazione - Supplied with - Equipés avec

Fornita senza accessori
Supplied without accessories
Equipés sans accessoires

Caratteristiche tecniche	Technical specifications	Données techniques		5,0 T-ARC 520	5,0 T-ARC 525
Alimentazione	Input voltage	Tension d'alimentation	Volt 50-60 Hz	1 Ph x 230/400	1 Ph x 230/400
Fusibile di rete	Fuse	Fusible	Amp	25 / 16	25 / 16
Potenza d'installazione	Installation power	Puissance d'installation	KW	4,4	4,0
Tensione a vuoto	Open circuit voltage	Tension à vide	Volt	43,5 - 49	43 - 48
Campo di regolazione	Welding current range	Champ de réglage	Amp	30 - 200	40 - 250
Elettrodi utilizzabili	Usable electrodes	Elettrodes utilisables	Ø mm	1,6 - 5,0	1,6 - 5,0
Servizio	Duty cycle	Facteur de marche	Amp	200 @ 10% 85 @ 60% 55 @ 100%	230 @ 10% 95 @ 60% 75 @ 100%
Dimensioni	Dimensions	Dimensions	mm	440 x 260 x 310	350 x 710 x 430
Peso	Weight	Poids	≈kg.	20,0	26,0



T-ARC Series



INDUSTRIAL

TRADITIONAL



1
PHASE



Caratteristiche

- **AC:** la corrente erogata è alternata. Consente di saldare elettrodi rutili, inox, etc.
- Doppia tensione a vuoto 50 / 70 Volt per saldare elettrodi scorrevoli e basici (T-ARC 529)
- Regolazione continua della corrente di saldatura
- Protezione termostatica

Features

- **AC:** the output current is alternating. It allows to weld rutile, stainless steel, etc. electrodes.
- Double open circuit voltage 50 / 70 Volt to weld with rutile and basic electrodes (T-ARC 529)
- Continuous setting of welding current
- Overload protection

Caractéristiques

- **AC:** le courant débité est alterné. Il permet de souder électrodes rutilles, inox, etc.
- Double tension à vide 50 / 70 Volt pour souder avec électrodes rutilles et basiques (T-ARC 529)
- Régulation continue du courant de soudure
- Protection thermostatique



OPTIONAL

KIT MMA - DS 20



000217

Dotazione - Supplied with - Equipés avec

Fornita senza accessori
Supplied without accessories
Equipés sans accessoires

Caratteristiche tecniche	Technical specifications	Données techniques		5.0 T-ARC 527	5.0 T-ARC 529
Alimentazione	Input voltage	Tension d'alimentation	Volt 50-60 Hz	1 Ph x 230/400	1 Ph x 230/400
Fusibile di rete	Fuse	Fusible	Amp	25 / 16	32 / 20
Potenza d'installazione	Installation power	Puissance d'installation	KW	3,5 / 4,5	3,5 / 4,5
Tensione a vuoto	Open circuit voltage	Tension à vide	Volt	42 - 48	42 - 70
Campo di regolazione	Welding current range	Champ de réglage	Amp	50 - 250	(50V) 50 - 250 (70V) 50 - 210
Elettrodi utilizzabili	Usable electrodes	Elettrodes utilisables	Ø mm	1,6 - 5,0	1,6 - 5,0
Servizio	Duty cycle	Facteur de marche	Amp	230 @ 15% 115 @ 60% 90 @ 100%	(50V) 230 @ 15% (70V) 190 @ 10% (50V) 115 @ 60% (70V) 75 @ 60% (50V) 90 @ 100% (70V) 60 @ 100%
Dimensioni	Dimensions	Dimensions	mm	420 x 380 x 750	420 x 380 x 750
Peso	Weight	Poids	≈kg.	33,5	34,0



T-ARC Series

MMA
INDUSTRIAL
TRADITIONAL

Caratteristiche

- AC: la corrente erogata è alternata. Consente di saldare elettrodi rutili, inox, etc.
- Doppia tensione a vuoto 50 / 70 Volt per saldare elettrodi scorrevoli e basici
- Regolazione continua della corrente di saldatura
- Protezione termostatica

Features

- AC: the output current is alternating. It allows to weld rutile, stainless steel, etc. electrodes.
- Double open circuit voltage 50 / 70 Volt to weld with rutile and basic electrodes
- Continuous setting of welding current
- Overload protection

Caractéristiques

- AC: le courant débité est alterné. Il permet de souder électrodes rutilles, inox, etc.
- Double tension à vide 50 / 70 Volt pour souder avec électrodes rutilles et basiques
- Régulation continue du courant de soudure
- Protection thermostatique



50/70V

1

PHASE



CE



OPTIONAL

T-ARC 530

T-ARC 845

KIT MMA - DS 35



000205

KIT MMA - DS 50



000207

Dotazione - Supplied with - Equipés avec

Fornita senza accessori
Supplied without accessories
Equipés sans accessoires

Caratteristiche tecniche	Technical specifications	Données techniques		5,0	T-ARC 530	8,0	T-ARC 845
Alimentazione	Input voltage	Tension d'alimentation	Volt 50-60 Hz		1 Ph x 230/400		1 Ph x 230/400
Fusibile di rete	Fuse	Fusible	Amp		32 / 25		63 / 50
Potenza d'installazione	Installation power	Puissance d'installation	KW 60%		10		17
Tensione a vuoto	Open circuit voltage	Tension à vide	Volt		50 - 70		62 - 70
Campo di regolazione	Welding current range	Champ de réglage	Amp		(50V) 15 - 300 (70V) 15 - 270		110 - 450
Elettrodi utilizzabili	Usable electrodes	Elettrodes utilisables	Ø mm		(50V) 1,6 - 5,0 (70V) 1,6 - 5,0		2,5 - 8,0
Servizio	Duty cycle	Facteur de marche	Amp		(50V) 210 @ 35% (50V) 160 @ 60%		310 @ 35% 235 @ 60% 180 @ 100%
Dimensioni	Dimensions	Dimensions	mm		490 x 780 x 615		490 x 780 x 615
Peso	Weight	Poids	≈kg.		62,5		74,0

P-ARC 525 AC/DC

MMA
PROFESSIONAL

TRADITIONAL

Caratteristiche

- **AC:** corrente alternata per saldare elettrodi rutili
- **DC:** corrente continua per saldare elettrodi basici (acciaio, inox, rame, bronzo, nichel, etc.)
- Regolazione continua della corrente di saldatura
- Protezione termostatica
- Prese professionali

Features

- **AC:** alternating current to weld rutile electrodes (steel, stainless steel, copper, bronze, nickel, etc.)
- **DC:** direct current to weld basic electrodes (steel, stainless steel, copper, bronze, nickel, etc.)
- Continuous setting of welding current
- Overload protection
- Professional sockets

Caractéristiques

- **AC:** courant alterné pour souder électrodes rutiles
- **DC:** courant continu pour souder électrodes basiques (acier, acier inox, cuivre, bronze, nickel, etc.)
- Régulation continue du courant de soudure
- Protection thermostatique
- Prises professionnelles



1

PHASE



TURBO



OPTIONAL



KIT MMA - DS 20



Dotazione - Supplied with - Equipés avec

Fornita senza accessori
Supplied without accessories
Equipés sans accessoires

Caratteristiche tecniche	Technical specifications	Données techniques		5,0	P-ARC 525 AC/DC
Alimentazione	Input voltage	Tension d'alimentation	Volt 50-60 Hz		1 Ph x 230/400
Fusibile di rete	Fuse	Fusible	Amp		25 / 16
Potenza d'installazione	Installation power	Puissance d'installation	KW 60%		4
Tensione a vuoto	Open circuit voltage	Tension à vide	Volt		(AC) 44 - 54 (DC) 38 - 47
Campo di regolazione	Welding current range	Champ de réglage	Amp		(AC) 40 - 250 (DC) 25 - 160
Elettrodi utilizzabili	Usable electrodes	Elettrodes utilisables	Ø mm		1,6 - 5,0
Servizio	Duty cycle	Facteur de marche	Amp		(AC) 230 @ 10% (DC) 160 @ 20% (AC) 95 @ 60% (DC) 95 @ 60%
Dimensioni	Dimensions	Dimensions	mm		350 x 710 x 430
Peso	Weight	Poids	=kg.		32,0



P-ARC Series

MMA
INDUSTRIAL
TRADITIONAL

Caratteristiche

- **DC:** la corrente erogata è continua, sia diretta che inversa. Consente di saldare con moltissimi tipi di elettrodi svariate qualità di metalli: rutili, basici, inox, ghisa, alluminio, etc.
- Regolazione continua della corrente di saldatura
- Prese professionali
- **CU:** Avvolgimenti in rame (P-ARC 846)

Features

- **DC:** the output current is direct, either electrode positive (DCEP) or electrode negative (DCEN). It allows to weld with many types of electrodes and materials: rutile, basic, stainless steel, cast iron, aluminum, etc.
- Continuous setting of welding current
- Professional sockets
- **CU:** Copper windings (P-ARC 846)

Caractéristiques

- **DC:** le courant débité est continu, aussi bien direct qu'inverse. Il permet de souder différents types de métaux en utilisant plusieurs types d'électrodes: cellulosique, rutile, basique, acier inox, fonte, aluminium, etc.
- Régulation continue du courant de soudure
- Prises professionnelles
- **CU:** Bobinage cuivre (P-ARC 846)



DC
- +

3
PHASE

ALUMINIUM

TURBO

CE

PG



OPTIONAL

P-ARC 526
P-ARC 735

P-ARC 840
P-ARC 846



Dotazione - Supplied with - Equipés avec

Fornita senza accessori
Supplied without accessories
Equipés sans accessoires

Caratteristiche tecniche	Technical specifications	Données techniques		5,0	P-ARC 526	7,0	P-ARC 735	8,0	P-ARC 840	8,0	P-ARC 846	CU
Alimentazione	Input voltage	Tension d'alimentation	Volt 50-60 Hz		3 Ph x 230/400		3 Ph x 230/400		3 Ph x 230/400		3 Ph x 230/400	
Fusibile di rete	Fuse	Fusible	Amp		32 / 20		50 / 32		63 / 40		80 / 50	
Potenza d'installazione	Installation power	Puissance d'installation	KW 60%		12		16		21		24	
Tensione a vuoto	Open circuit voltage	Tension à vide	Volt		59 - 68,5		62,5 - 72,5		62 - 72,5		66 - 80	
Campo di regolazione	Welding current range	Champ de réglage	Amp		40 - 260		60 - 350		65 - 400		65 - 460	
Elettrodi utilizzabili	Usable electrodes	Elettrodes utilisables	Ø mm		1,6 - 5,0		2,0 - 7,0		2,0 - 8,0		2,0 - 8,0	
Servizio	Duty cycle	Facteur de marche	Amp		200 @ 35% 155 @ 60% 120 @ 100%		300 @ 35% 230 @ 60% 180 @ 100%		380 @ 35% 270 @ 60% 210 @ 100%		450 @ 35% 340 @ 60% 260 @ 100%	
Dimensioni	Dimensions	Dimensions	mm		490 x 780 x 615				570 x 890 x 780			
Peso	Weight	Poids	≈kg.		66,5		107,5		119,0		145,0	

E-ARC Series

THYRISTOR
CONTROLLED

MMA
INDUSTRIAL

TRADITIONAL

Caratteristiche

- **DC:** la corrente erogata è continua, sia diretta che inversa. Consente di saldare con moltissimi tipi di elettrodi svariate qualità di metalli: cellulósici, rutili, basici, inox, ghisa, alluminio, etc.
- **Regolazione elettronica della corrente di saldatura**
- **Regolazione Hot Start e Arc Force**
- **Funzione Anti Sticking**
- **Saldatura TIG LIFT**
- **Elettrovalvola per il controllo del flusso del gas**
- Doppia protezione termostatica
- Predisposizione per comando a distanza

Features

- **DC:** the output current is direct, either electrode positive (DCEP) or electrode negative (DCEN). It allows to weld with many types of electrodes and materials: cellulosic, rutile, basic, stainless steel, cast iron, aluminium, etc.
- **Electronic welding current setting**
- **Hot start and Arc Force setting**
- **Anti Sticking function**
- **TIG LIFT welding**
- **Solenoid valve to control the flow of gas**
- Double thermal protection
- Remote control connector

Caractéristiques

- **DC:** le courant débité est continu, aussi bien direct qu'inverse. Il permet de souder différents types de métaux en utilisant plusieurs types d'électrodes: cellulósique, rutile, basique, acier inox, fonte, aluminium, etc.
- **Réglage électronique du courant de soudure**
- **Réglage Hot Start et Arc Force**
- **Anti Sticking fonction**
- **Soudure TIG LIFT**
- **Electrovalve pour contrôler le flux du gaz**
- Double protection thermostatique
- Prévu pour contrôle à distance



DC
- +

3
PHASE

CELLULOSIC

ALUMINIUM

TIG
LIFT

MICRO
PROCESSOR

THYRISTOR
CONTROLLED

TURBO

CE

PG

DC
- +

OPTIONAL

E-ARC 840

E-ARC 860

E-ARC 840
E-ARC 860

KIT MMA - DS 50



000207

KIT MMA - DS 60



000209

TIG Torch 180A 4 mt.



010230

Dotazione - Supplied with - Equipés avec

Remote Control 4 mt.



Caratteristiche tecniche	Technical specifications	Données techniques		8,0	E-ARC 840	8,0	E-ARC 860
Alimentazione	Input voltage	Tension d'alimentation	Volt 50-60 Hz		3 Ph x 230/400		3 Ph x 230/400
Fusibile di rete	Fuse	Fusibile	Amp		40 / 25		50 / 37
Potenza d'installazione	Installation power	Puissance d'installation	KW 60%		15		20
Tensione a vuoto	Open circuit voltage	Tension à vide	Volt		85		85
Campo di regolazione	Welding current range	Champ de réglage	Amp		20 - 380		20 - 550
Elettrodi utilizzabili	Usable electrodes	Elettrodes utilisables	Ø mm		2,0 - 8,0		2,0 - 8,0
Servizio	Duty cycle	Facteur de marche	Amp		350 @ 35% 270 @ 60% 210 @ 100%		500 @ 35% 380 @ 60% 295 @ 100%
Dimensioni	Dimensions	Dimensions	mm		800 x 585 x 760		
Peso	Weight	Poids	≈kg.		115,0		130,0



TIG

Tungsten Inert Gas
(gas Argon pure)





LIGHT DUTY

SILTIG 415

Pag. 28



PROFESSIONAL

MASTROTIG 216 AC/DC

Pag. 32



INDUSTRIAL

MASTROTIG 200

Pag. 29

MASTROTIG 218 DC

Pag. 31

MASTROTIG 327 AC/DC

Pag. 33

DECATIG 200

Pag. 35

SILTIG 415

TIG
LIGHT DUTY
INVERTER

Caratteristiche

- **TIG LIFT**: è ideale per chiunque necessiti la finezza ed accuratezza di lavoro, ottenibile solo con il processo TIG. I materiali saldabili sono: inox, rame, nichel, etc. a partire da 0,5mm. di spessore.
- **DC**: la corrente erogata è continua, sia diretta che inversa. Consente di saldare con moltissimi tipi di elettrodi svariate qualità di metalli.
- **HOT START regolabile**: uno spunto di potenza aggiuntiva (booster) facilita l'innesco dell'arco. Molto utile per gli elettrodi di difficile innesco
- **ANTI-STICKING**: elimina il fastidio dell'incollamento dell'elettrodo al pezzo. Evita il surriscaldamento dell'elettrodo proteggendone le caratteristiche.
- **ARC FORCE regolabile**: aumenta gli ampere quando l'arco di saldatura è tenuto corto. Incrementa la penetrazione degli elettrodi e migliora le caratteristiche meccaniche del giunto saldato.
- **Protezione termostatica, sovratensione, *motogeneratore +/- 15%**

Features

- **TIG LIFT**: It's ideal for anyone who requires the finesse available only from TIG process. You can weld: steel, stainless steel, copper, nickel etc., starting from 0,5 mm.
- **DC**: the output current is direct, either electrode positive (DCEP) or electrode negative (DCEN). It allows to weld with many types of electrodes and materials.
- **HOT START adjustable**: built-in "hot start" for easy electrode striking. Useful especially for "difficult-to-start" electrodes.
- **ANTI-STICKING**: no electrode sticking. It avoids the electrode's overheating, protecting its metallurgical features.
- **ARC FORCE adjustable**: it gives additional amperage during short arc length conditions while welding. It increases the electrodes penetration, improving the mechanical features of the welded joint.
- **Thermostatical protection, overvoltage, *motogenerator +/- 15%**

Caractéristiques

- **TIG LIFT**: Idéal pour qui doit effectuer un travail très fin et soigné: un résultat pouvant être obtenu uniquement au moyen du procédé TIG. Les matériaux pouvant être soudés sont les suivants: inox, cuivre, nickel etc. à partir de 0,5 mm. d'épaisseur.
- **DC**: le courant débité est continu, aussi bien direct qu'inverse. Il permet de souder différents types de métaux en utilisant plusieurs types d'électrodes.
- **HOT START réglable**: une puissance d'admission additionnelle (booster) facilite l'amorçage de l'arc. Très utile pour les électrodes que l'on peut difficilement amorcer.
- **ANTI-STICKING**: élimine l'inconvénient représenté par le collage de l'électrode à la pièce. Évite la surcharge de l'électrode et préserve les caractéristiques de ce dernier.
- **ARC FORCE réglable**: augmente les ampères lorsque l'arc de soudage est maintenu "court". Augmente la pénétration des électrodes et améliore les caractéristiques mécaniques du joint soudé.
- **Protections thermostatique, sournoltage, *motogenerateur +/- 15%**



DC
-+

TIG
LIFT

1
PHASE

MICRO
PROCESSOR

GENERATOR

TURBO

CE

PG

OPTIONAL



Dotazione - Supplied with - Equipés avec

- Kit TIG
- + Valigia
- + Carry Case
- + Valis



Caratteristiche tecniche	Technical specifications	Données techniques		SILTIG 415
Alimentazione	Input voltage	Tension d'alimentation	Volt 50-60 Hz	1 Ph x 230
Fusibile di rete	Fuse	Fusible	Amp	16
Potenza d'installazione	Installation power	Puissance d'installation	KW	4,5
Tensione a vuoto	Open circuit voltage	Tension à vide	Volt	102
Elettrodi utilizzabili	Usable electrodes	Elettrodes utilisables	Ø mm	TIG 1,6 - MMA 1,6 - 4,0
Campo di regolazione	Welding current range	Champ de réglage	Amp	10 - 150
Servizio	Duty cycle	Facteur de marche	Amp DECA use at 20°C	150 @ 60%
Servizio	Duty cycle	Facteur de marche	Amp EN 60974-1 40°C	140 @ 10%
Dimensioni	Dimensions	Dimensions	mm	132 x 335 x 206
Peso	Weight	Poids	=kg.	3,6

MASTROTIG 200

TIG
INDUSTRIAL
INVERTER

Caratteristiche

- **DC:** la corrente erogata è continua, sia diretta che inversa. Consente di saldare con moltissimi tipi di elettrodi svariate qualità di metalli.
- **MMA:** saldatura ad elettrodo rivestito.
- **TIG LIFT:** saldatura TIG con innescò LIFT ARC.
- **TIG HF:** saldatura TIG con innescò ad alta frequenza
- **TIG 2T / 4T:** saldatura manuale / automatica
- **HOT START REGOLABILE:** (MMA) uno spunto di potenza aggiuntiva (booster) facilita l'innescò dell'arco. Molto utile per gli elettrodi di difficile innescò.
- **SLOPE DOWN REGOLABILE:** (TIG): Regolazione di fine saldatura. Serve per ridurre il cratere che tende a formarsi a fine della saldatura.
- **ARC FORCE:** (MMA) aumenta gli ampere quando l'arco di saldatura è tenuto corto. Incrementa la penetrazione degli elettrodi e migliora le caratteristiche meccaniche del giunto saldato.
- **ANTI-STICKING:** (MMA) elimina il fastidio dell'incollamento dell'elettrodo al pezzo. Evita il surriscaldamento dell'elettrodo proteggendone le caratteristiche.
- **TIG BI-LEVEL:** selezione di due livelli di corrente durante la saldatura
- **PRE-GAS / POST-GAS:** regolazione automatica in base alla corrente ed alla durata della saldatura.



DC
-+

1
PHASE

TIG
HF

TIG
LIFT

MICRO
PROCESSOR

GENERATOR

TURBO

CE

PG

GENERATOR
OUTPUT-VOLTAGE
+/- 30%

Features

- **DC:** the output current is direct, either electrode positive (DCEP) or electrode negative (DCEN). It allows to weld with many types of electrodes and materials.
- **MMA:** welding with coated electrode.
- **TIG LIFT:** TIG welding with LIFT ARC striking.
- **TIG HF:** TIG welding with high frequency arc striking.
- **TIG 2T / 4T:** manual / automatic welding
- **HOT START ADJUSTABLE:** for easy electrode striking. Useful especially for "difficult-to-start" electrodes.
- **SLOPE DOWN ADJUSTABLE:** (TIG): Setting of end-weld. This help to reducing the crater which is produced when the weld is terminated.
- **ARC FORCE:** (MMA) it gives additional amperage during short arc length conditions while welding. It increases the electrodes penetration, improving the mechanical features of the welded joint.
- **ANTI-STICKING:** (MMA) no electrode sticking. It avoids the electrode's overheating, protecting its metallurgical features.
- **TIG BI-LEVEL:** two different current settings are selectable during welding process
- **PRE-GAS / POST-GAS:** automatically adjusted according to the value of welding current and duration of the weld.

Caractéristiques

- **C.C.:** le courant débité est continu, aussi bien direct qu'inverse. Il permet de souder différents types de métaux en utilisant plusieurs types d'électrodes.
- **MMA:** soudage avec électrode enrobée.
- **TIG LIFT:** soudage TIG avec amorçage LIFT ARC
- **TIG HF:** soudage TIG avec amorçage à haute fréquence.
- **TIG 2T / 4T:** soudure manuelle / automatique.
- **HOT START RÉGLABLE:** une puissance d'admission additionnelle (booster) facilite l'amorçage de l'arc. Très utile pour les électrodes que l'on peut difficilement amorcer.
- **SLOPE DOWN RÉGLABLE:** (TIG): Réglage de la fin de soudage. Cela permet de réduire le cratère qui se forme à la fin de la soudure
- **ARC FORCE:** (MMA) augmente les ampères lorsque l'arc de soudage est maintenu "court". Augmente la pénétration.
- **ANTI-STICKING:** (MMA) élimine l'inconvénient représenté par le collage de l'électrode à la pièce. Évite la surcharge de l'électrode et préserve les caractéristiques de ce dernier.
- **TIG BI-LEVEL:** deux différents paramètres du courant de soudage sont sélectionnables lors de processus de soudage.
- **PRE-GAS / POST-GAS:** il est réglé automatiquement par le microprocesseur en fonction de l'intensité de courant et de la durée de soudage.

OPTIONAL



Dotazione - Supplied with - Equipés avec



Caratteristiche tecniche	Technical specifications	Données techniques	MASTROTIG 200	
Alimentazione	Input voltage	Tension d'alimentation	Volt 50-60 Hz	1 Ph x 230
Fusibile di rete	Fuse	Fusible	Amp	25
Potenza d'installazione	Installation power	Puissance d'installation	KW	5 - 7
Tensione a vuoto	Open circuit voltage	Tension à vide	Volt	80
Campo di regolazione	Welding current range	Champ de réglage	Amp	TIG 5 - 200 MMA 30 - 180
Elettrodi utilizzabili	Usable electrodes	Elettrodes utilisables	Ø mm	TIG 1,6 - 3,2 MMA 1,6 - 4,0
Servizio	Duty cycle	Facteur de marche	Amp	200 @ 40% 165 @ 60%
Dimensioni	Dimensions	Dimensions	mm	400 x 160 x 260
Peso	Weight	Poids	≈kg.	7,8



MASTROTIG Control Panel



MASTROTIG DC

MASTROTIG AC/DC

Saldatura Tig: parametri regolabili

- a) Φ mm: Selezione del diametro dell'elettrodo di tungsteno. In base al diametro selezionato, la macchina determina l'intervallo di corrente di saldatura che puoi utilizzare senza danneggiare l'elettrodo.
- b) PREGAS: Regolazione del tempo di pre-gas.
- c) SLOPE-UP: Regolazione del tempo con cui la corrente di saldatura si porta dal valore iniziale (innescio dell'arco) al valore principale "I (Amp)".
- d) I (Amp): Regolazione della corrente principale di saldatura.
- e) (%) I: Nella modalità "PULSE" e "BILEVEL 4T" regola la corrente di saldatura di base, espressa come percentuale della corrente principale di saldatura.
- f) SLOPE-DOWN: Tempo con cui, dopo il rilascio del pulsante torcia, la corrente di saldatura si porta dal valore principale al valore finale (termine della saldatura).
- g) POSTGAS: Regolazione del tempo di post-gas.
- h) PULSE (Hz): Nella modalità "TIG PULSE" varia la frequenza di pulsazione.
- i) BALANCE (%) (TIG AC): Nella modalità di saldatura in corrente alternata, modifica il rapporto fra la durata della semionda positiva e della semionda negativa. Bassi valori di "balance" consentono maggiore penetrazione dell'arco e poca usura dell'elettrodo. Alti valori di "balance" consentono maggiore pulizia del pezzo ma elevata usura dell'elettrodo.
- l) FREQUENCY (Hz) (TIG AC): Nella modalità di saldatura in corrente alternata, varia la frequenza della corrente di saldatura. Bassi valori consentono un arco più distribuito. Alti valori consentono un arco più concentrato.
- m) T (SPOT): Nella modalità "SPOT" varia la durata del punto di saldatura.

Tig welding: adjustable parameters

- a) Φ mm: Select the diameter of the tungsten electrode. Based on the diameter selected, the machine determines the welding current interval that can be used without damaging the electrode.
- b) PREGAS: Pre-gas time adjustment.
- c) SLOPE-UP: Adjustment of time at which the welding current is brought from the initial value (arc start) to the main value "I (Amp)".
- d) I (Amp): Main welding current adjustment.
- e) (%) I: In the "PULSE" and "BILEVEL 4T" modes, it adjusts the base welding current, expressed as a percentage of the main welding current.
- f) SLOPE-DOWN: Time at which, once the torch button is released, the welding current is brought from the main value to the final value (end of welding).
- g) POSTGAS: Post-gas time adjustment.
- h) PULSE (Hz): In the "TIG PULSE" mode, it varies the pulse frequency.
- i) BALANCE (%) : In the "TIG AC" welding mode at alternating current, it modifies the ratio between the duration of the positive and the negative half waves. Low "balance" values allow for enhanced arc penetration and little electrode wear and tear. High "balance" values allow for better cleaning of the workpiece but increased electrode wear and tear.
- l) FREQUENCY (Hz): In the "TIG AC" welding mode at alternating current, it varies the welding current frequency. Low values allow for a better distributed arc. High values allow for a more concentrated arc.
- m) T (SPOT): In the "SPOT" mode it varies the duration of the welding point.

Soudage Tig : paramètres réglables

- a) Φ mm: Sélection du diamètre de l'électrode en tungstène. En fonction du diamètre sélectionné, la machine détermine l'intervalle de courant de soudage que l'on peut utiliser sans endommager l'électrode.
- b) PREGAS: Réglage du temps de pré-gaz.
- c) SLOPE-UP: Réglage du temps qu'emploie le courant de soudage pour passer de la valeur initiale (amorçage de l'arc) à la valeur principale "I (Amp)".
- d) I (Amp): Réglage du courant principal de soudage.
- e) (%) I: En modes "PULSE" et "BILEVEL 4T" Règle le courant de soudage de base, exprimé sous forme de pourcentage du courant principal de soudage.
- f) SLOPE-DOWN: Temps qu'emploie le courant de soudage pour passer de la valeur principale à la valeur finale (fin du soudage) après le relâchement du bouton de la torche.
- g) POSTGAS: Réglage du temps de post-gaz.
- h) PULSE (Hz): En mode "TIG PULSE" la fréquence de pulsation varie.
- i) BALANCE (%) : En mode de soudage "TIG AC" en courant alternatif, il modifie le rapport entre la durée de la demi-onde positive et de la demi-onde négative. Les faibles valeurs de "balance" permettent une meilleure pénétration de l'arc et une faible usure de l'électrode. Des valeurs de "balance" élevées signifient une plus grande propreté de la pièce mais une forte usure de l'électrode.
- l) FREQUENCY (Hz): En mode de soudage "TIG AC" en courant alternatif, la fréquence du courant de soudage varie. De faibles valeurs permettent d'obtenir un arc plus réparti. De hautes valeurs correspondent à un arc plus concentré.
- m) T (SPOT): En mode "SPOT" la durée du point de soudage varie.

MASTROTIG 218 DC

TIG
INDUSTRIAL
INVERTER

NEW

Saldatura MMA in corrente continua DC

- Consente di saldare con moltissimi tipi di elettrodi svariate qualità di metalli: rutili, basici, inox, ghisa, etc.
- **HOT START** regolabile.
- **ARC FORCE** regolabile.
- **ANTI-STICKING**.

Saldatura TIG DC

- **DC**: corrente continua per saldare acciaio ed inox, titanio, rame, bronzo, nichel, ottone.
- **PULSE**: La corrente di saldatura è pulsata. Si alternano la corrente principale "I (Amp)" e la corrente di base "(%) I". Particolarmente indicata per saldare spessori sottili, dove è necessario un basso riscaldamento del pezzo, ed adatta a saldare in tutte le posizioni.
- **EASY PULSE**: La regolazione della frequenza di pulsazione "PULSE (Hz)" e della corrente di base "(%) I" è automatica, in funzione dei parametri di saldatura impostati.
- **BI-LEVEL**: selezione di due livelli di corrente durante la saldatura.
- **Innesco TIG HF / LIFT**.
- **2T (manuale) - 4T (automatico) - SPOT**
- **Memorizzazione programmi**. I programmi memorizzabili sono 9.

MMA welding in direct current DC

- It allows to weld with many types of electrodes and materials: rutile, basic, stainless steel, cast iron, etc.
- **HOT START** adjustable.
- **ARC FORCE** adjustable.
- **ANTI - STICKING**.

DC TIG welding

- **DC**: direct current to weld steel, stainless steel, titanium, copper, bronze, nickel.
- **PULSE**: The welding current is pulsed. Main current "I (Amp)" and base current "(%) I" alternate. Particularly suitable for welding thin thickness, where minimum heating of the piece is necessary, and suitable for welding in all positions.
- **EASY PULSE**: Pulse frequency, "PULSE (Hz)", and base current "(%) I" are adjusted automatically depending on the welding parameters selected.
- **BI-LEVEL**: two different current settings are selectable during welding process.
- **TIG HF / LIFT striking**.
- **2T (manual) - 4T (automatic) - SPOT**
- **Program saving**. There are 9 programs to be saved.

Soudure MMA en courant continu DC

- Il permet de souder différents types de métaux en utilisant plusieurs types d'électrodes: rutilles, basiques, inox, fonte, etc.
- **HOT START** réglable.
- **ARC FORCE** réglable.
- **ANTI-STICKING**.

Soudure TIG DC

- **DC**: courant continu pour souder acier, acier inox, titanium, cuivre, bronze, nickel.
- **PULSE**: Le courant de soudage est pulsé. Le courant principal "I (Amp)" s'alterne avec le courant de base "(%) I". Particulièrement indiquée pour souder de l'épaisseur fine, là où il faut un faible réchauffement du morceau, et adapte pour souder dans toutes les positions.
- **EASY PULSE**: Le réglage de la fréquence de pulsation "PULSE (Hz)" et du courant de base "(%) I" est automatique, en fonction des paramètres de soudage sélectionnés.
- **TIG BI-LEVEL**: deux différents paramètres du courant de soudage sont sélectionnables lors de processus de soudage.
- **Amorçage TIG HF / LIFT**.
- **2T (manuel) - 4T (automatique) - SPOT**
- **Mémorisation des programmes**. Il y a 9 programmes susceptibles d'être mémorisés.

OPTIONAL



Dotazione - Supplied with - Equipés avec



Caratteristiche tecniche	Technical specifications	Données techniques	MASTROTIG 218 DC	
Alimentazione	Input voltage	Tension d'alimentation	1 Ph x 230	
Fusibile di rete	Fuse	Fusible	25	
Potenza d'installazione	Installation power	Puissance d'installation	5,7	
Tensione a vuoto	Open circuit voltage	Tension à vide	90	
Campo di regolazione	Welding current range	Champ de réglage	Amp	
			TIG	MMA
Elettrodi utilizzabili	Usable electrodes	Elettrodes utilisables	10 - 200	20 - 180
Servizio	Duty cycle	Facteur de marche	Amp	
			1 - 3,2	1,6 - 5,0
Dimensioni	Dimensions	Dimensions	Amp	
			200 @ 30%	180 @ 30%
Peso	Weight	Poids	Amp	
			140 @ 60%	130 @ 60%
			418 x 196 x 343	
			9	



MASTROTIG 216 AC/DC



TIG
PROFESSIONAL

INVERTER



1
PHASE

TIG
HF

TIG
LIFT

MICRO
PROCESSOR

EASY
PULSE

TURBO

CE

PC

Saldatura MMA in corrente continua DC

- Consente di saldare con moltissimi tipi di elettrodi svariate qualità di metalli: rutili, basici, inox, ghisa, etc.
- **HOT START - ARC FORCE** regolabile.
- **ANTI-STICKING**.

Saldatura TIG AC / DC

- **DC**: corrente continua per saldare acciaio ed inox, titanio, rame, bronzo, nichel, ottone.
- **AC**: corrente alternata per saldare alluminio, magnesio.
- **AC EASY**: La regolazione della frequenza "FREQUENCY (Hz)" e del "BALANCE (%)" è automatica, in funzione dei parametri di saldatura selezionati.
- **PULSE**: La corrente di saldatura è pulsata. Si alternano la corrente principale "I (Amp)" e la corrente di base "(%) I".
- **EASY PULSE**: La regolazione della frequenza di pulsazione "PULSE (Hz)" e della corrente di base "(%) I" è automatica, in funzione dei parametri di saldatura impostati.
- **BI-LEVEL**: selezione di due livelli di corrente durante la saldatura.
- **Innesco TIG HF / LIFT**.
- **2T (manuale) - 4T (automatico) - SPOT**
- **Memorizzazione programmi**. I programmi memorizzabili sono 9.

MMA welding in direct current DC

- It allows to weld with many types of electrodes and materials: rutile, basic, stainless steel, cast iron, etc.
- **HOT START - ARC FORCE** adjustable.
- **ANTI - STICKING**.

AC / DC TIG welding

- **DC**: direct current to weld steel, stainless steel, titanium, copper, bronze, nickel.
- **AC**: alternating current to weld aluminium, magnesium.
- **AC EASY**: FREQUENCY (Hz) and BALANCE (%) are automatically adjusted depending on the welding parameters set.
- **PULSE**: The welding current is pulsed. Main current "I (Amp)" and base current "(%) I" alternate.
- **EASY PULSE**: Pulse frequency, "PULSE (Hz)", and base current "(%) I" are adjusted automatically depending on the welding parameters selected.
- **BI-LEVEL**: two different current settings are selectable during welding process.
- **TIG HF / LIFT striking**.
- **2T (manual) - 4T (automatic) - SPOT**
- **Program saving**. There are 9 programs to be saved.

Soudure MMA en courant continu DC

- Il permet de souder différents types de métaux en utilisant plusieurs types d'électrodes: rutilies, basiques, inox, fonte, etc.
- **HOT START - ARC FORCE** réglable.
- **ANTI-STICKING**.

Soudure TIG AC / DC

- **DC**: courant continu pour souder acier, acier inox, titanium, cuivre, bronze, nickel.
- **AC**: courant alterné pour souder aluminium, magnesium.
- **AC EASY**: Le réglage de la fréquence "FREQUENCY (Hz)" et du "BALANCE (%)" est automatique, en fonction des paramètres de soudage programmés.
- **PULSE**: Le courant de soudage est pulsé. Le courant principal "I (Amp)" s'alterne avec le courant de base "(%) I".
- **EASY PULSE**: Le réglage de la fréquence de pulsation "PULSE (Hz)" et du courant de base "(%) I" est automatique, en fonction des paramètres de soudage sélectionnés.
- **TIG BI-LEVEL**: deux différents paramètres du courant de soudage sont sélectionnables lors de processus de soudage.
- **Amorçage TIG HF / LIFT**.
- **2T (manuel) - 4T (automatique) - SPOT**
- **Mémorisation des programmes**. Il y a 9 programmes susceptibles d'être mémorisés.



AC
EASY

EASY
PULSE

OPTIONAL

000217	010204	010302	010890

Dotazione - Supplied with - Equipés avec

--	--

Caratteristiche tecniche	Technical specifications	Données techniques	MASTROTIG 216 AC/DC		
Alimentazione	Input voltage	Tension d'alimentation	1 Ph x 230		
Fusibile di rete	Fuse	Fusible	16		
Potenza d'installazione	Installation power	Puissance d'installation	4		
Tensione a vuoto	Open circuit voltage	Tension à vide	105		
Campo di regolazione	Welding current range	Champ de réglage	Amp	TIG	MMA
				5 - 160	20 - 130
Elettrodi utilizzabili	Usable electrodes	Elettrodes utilisables	Ø mm	1 - 3,2	1,6 - 3,2
				160 @ 20%	130 @ 25%
Servizio	Duty cycle	Facteur de marche	Amp	85 @ 60%	80 @ 60%
				415 x 193 x 417	
Dimensioni	Dimensions	Dimensions	mm		
Peso	Weight	Poids	=kg.		
			11		



MASTROTIG 327 AC/DC

TIG
INDUSTRIAL

INVERTER



3
PHASE

TIG
HF

TIG
LIFT

MICRO
PROCESSOR

EASY
PULSE

TURBO

CE

PC

Saldatura MMA in corrente continua DC

- Consente di saldare con moltissimi tipi di elettrodi svariate qualità di metalli: rutili, basici, inox, ghisa, etc.
- **HOT START regolabile.** Facilita l'innescio dell'arco di saldatura con elettrodi particolarmente difficili.
- **ARC FORCE regolabile.** Permette di controllare la penetrazione della saldatura e migliora la stabilità d'arco.
- **ANTI-STICKING.** Evita l'incollatura dell'elettrodo al pezzo.

Saldatura TIG AC / DC

- **DC:** corrente continua per saldare acciaio ed inox, titanio, rame, bronzo, nichel, ottone.
- **AC:** corrente alternata per saldare alluminio, magnesio.
- **AC EASY:** La regolazione della frequenza "FREQUENCY (Hz)" e del "BALANCE (%)" è automatica, in funzione dei parametri di saldatura selezionati.
- **PULSE:** La corrente di saldatura è pulsata. Si alternano la corrente principale "I (Amp)" e la corrente di base "(%) I". Particolarmente indicata per saldare spessori sottili, dove è necessario un basso riscaldamento del pezzo, ed adatta a saldare in tutte le posizioni.
- **EASY PULSE:** La regolazione della frequenza di pulsazione "PULSE (Hz)" e della corrente di base "(%) I" è automatica, in funzione dei parametri di saldatura selezionati.
- **BI-LEVEL:** selezione di due livelli di corrente durante la saldatura. Estremamente utile per saldature complesse; su spessori variabili o in posizione.
- **Innesco TIG HF / LIFT:** saldatura TIG con innesco ad alta frequenza / saldatura TIG con innesco LIFT ARC.
- **2T (manuale):** si salda fino a che il pulsante torcia viene mantenuto premuto.
- **4T (automatico):** premi e rilascia il tasto per iniziare a saldare, la saldatura continua fino a che non premi e rilasci il pulsante nuovamente per interromperla.
- **SPOT:** La saldatura TIG termina automaticamente, una volta trascorso il tempo impostato.
- **Memorizzazione programmi.** E' possibile memorizzare le impostazioni delle modalità e dei parametri impostati sulla macchina per un utilizzo futuro. I programmi memorizzabili sono 9.

MMA welding in direct current DC

- It allows to weld with many types of electrodes and materials: rutile, basic, stainless steel, cast iron, etc.
- **HOT START adjustable.** For easy electrode striking. Useful especially for "difficult-to-start" electrodes.
- **ARC FORCE adjustable.** Enables to control the welding penetration and improve the arc stability.
- **ANTI - STICKING.** No electrode sticking.

AC / DC TIG welding

- **DC:** direct current to weld steel, stainless steel, titanium, copper, bronze, nickel.
- **AC:** alternating current to weld aluminium, magnesium.
- **AC EASY:** FREQUENCY (Hz) and BALANCE (%) are automatically adjusted depending on the welding parameters set.
- **PULSE:** The welding current is pulsed. Main current "I (Amp)" and base current "(%) I" alternate. Particularly suitable for welding thin thickness, where minimum heating of the piece is necessary, and suitable for welding in all positions.
- **EASY PULSE:** Pulse frequency, "PULSE (Hz)", and base current "(%) I" are adjusted automatically depending on the welding parameters selected.
- **BI-LEVEL:** two different current settings are selectable during welding process. Extremely useful for complex welding, welding over variable thicknesses or for welding on position.
- **TIG HF / LIFT striking:** TIG welding with high frequency arc striking / TIG welding with LIFT ARC striking.
- **2T (manual):** press and keep the torch trigger pressed to weld, the weld will stop as soon as the button is released.
- **4T (automatic):** press and release the torch trigger to start welding, the weld will last until the trigger is pressed and released once again.
- **SPOT:** TIG welding finishes automatically once the pre-set time has elapsed.
- **Program saving.** The mode settings and the parameters set can be saved to the machine for future use. There are 9 programs to be saved.

Soudure MMA en courant continu DC

- Il permet de souder différents types de métaux en utilisant plusieurs types d'électrodes: rutilés, basiques, inox, fonte, etc.
- **HOT START réglable.** Très utile pour les électrodes que l'on peut difficilement amorcer.
- **ARC FORCE réglable.** Permet de régler la pénétration de soudage et optimise la stabilité de l'arc de soudage.
- **ANTI-STICKING.** Élimine le collage de l'électrode à la pièce.

Soudure TIG AC / DC

- **DC:** courant continu pour souder acier, acier inox, titanium, cuivre, bronze, nickel.
- **AC:** courant alternatif pour souder aluminium, magnesium.
- **AC EASY:** Le réglage de la fréquence "FREQUENCY (Hz)" et du "BALANCE (%)" est automatique, en fonction des paramètres de soudage programmés.
- **PULSE:** Le courant de soudage est pulsé. Le courant principal "I (Amp)" s'alterne avec le courant de base "(%) I". Particulièrement indique pour souder de l'épaisseur fine, la ou il faut un faible rechauffement du morceau, et adapte pour souder dans toutes les positions.
- **EASY PULSE:** Le réglage de la fréquence de pulsation "PULSE (Hz)" et du courant de base "(%) I" est automatique, en fonction des paramètres de soudage sélectionnés.
- **TIG BI-LEVEL:** deux différents paramètres du courant de soudage sont sélectionnables lors de processus de soudage. Utile pour des soudages complexes, des soudages sur épaisseurs variables ou en position.
- **Amorçage TIG HF / LIFT:** soudage TIG avec amorçage à haute fréquence / soudage TIG avec amorçage LIFT ARC.
- **2T (manuel):** on soude tant que le bouton torche est enfoncé.
- **4T (automatic):** appuyer sur le bouton et le relâcher pour commencer à souder, la soudure continue jusqu'à ce que l'on appuie et relâche de nouveau le bouton pour l'interrompre.
- **SPOT:** Le soudage TIG s'achève automatiquement une fois le temps écoulé, tel que programmé.
- **Mémorisation des programmes.** Il est possible de mémoriser les configurations de modes et de paramètres programmés sur la machine pour un emploi futur. Il y a 9 programmes susceptibles d'être mémorisés.



MASTROTIG 327 AC/DC

TIG

INDUSTRIAL

INVERTER

AC DC

3 PHASE

TIG HF

TIG LIFT

MICRO PROCESSOR

EASY PULSE

TURBO

CE

PC



AC EASY PULSE

OPTIONAL



MASTROTIG 327 AC/DC H2O



WU IO

Impianto di raffreddamento
Water cooling unit
Unité de refroidissement
010664



Dotazione
Supplied with
Equipés avec



Caratteristiche tecniche	Technical specifications	Données techniques		MASTROTIG 327 AC/DC	
Alimentazione	Input voltage	Tension d'alimentation	Volt 50-60 Hz	3 Ph x 400	
Fusibile di rete	Fuse	Fusible	Amp	16	
Potenza d'installazione	Installation power	Puissance d'installation	KW	10	
Tensione a vuoto	Open circuit voltage	Tension à vide	Volt	55	
				TIG	MMA
Campo di regolazione	Welding current range	Champ de réglage	Amp	5 - 270	20 - 270
Elettrodi utilizzabili	Usable electrodes	Elettrodes utilisables	Ø mm	1 - 4,0	1,6 - 6,0
Servizio	Duty cycle	Facteur de marche	Amp	270 @ 40%	270 @ 40%
				215 @ 60%	215 @ 60%
Dimensioni	Dimensions	Dimensions	mm	550 x 250 x 490	
Peso	Weight	Poids	≈kg.	32	



DECATIG 200E

 **TIG**
INDUSTRIAL
TRADITIONAL

AC **DC**
 

1
PHASE

TIG
HF

TURBO

CE

PG

Caratteristiche TIG

- **AC:** corrente alternata per saldare alluminio, magnesio ed elettrodi rutili
- **DC:** corrente continua per saldare acciaio ed inox, titanio, rame, bronzo, nichel, ottone
- **HF:** generatore elettronico di alta frequenza per l'innesco dell'arco di saldatura senza contatto
- Pre-gas fisso / post-gas regolabile
- Regolazione continua della corrente di saldatura
- Protezione termostatica

Caratteristiche MMA

- **AC:** corrente alternata per saldare elettrodi rutili
- **DC:** corrente continua per saldare acciaio, inox, rame, bronzo, nichel
- Regolazione continua della corrente di saldatura
- Protezione termostatica
- Prese professionali

TIG Features

- **AC:** alternating current to weld aluminium, magnesium and rutile electrodes
- **DC:** direct current to weld steel, stainless steel, titanium, copper, bronze, nickel
- **HF:** high frequency generator for arc striking without contact
- Preset gas flow / Adjustable post gas
- Continuous regulation of welding current
- Overload protection

MMA Features

- **AC:** alternating current to weld rutile electrodes
- **DC:** direct current to weld steel, stainless steel, copper, bronze, nickel
- Continuous regulation of welding current
- Overload protection
- Professional sockets

Caractéristiques TIG

- **AC:** courant alterné pour souder aluminium, magnésium et électrodes rutilés
- **DC:** courant continu pour souder acier, acier inox, titane, cuivre, bronze, nickel
- **HF:** générateur électronique à haute fréquence pour l'amorçage de l'arc sans contact
- Pré gaz fixe / Post gaz réglable
- Régulation continue du courant de soudure
- Protection thermostatique

Caractéristiques MMA

- **AC:** courant alterné pour souder électrodes rutilés
- **DC:** courant continu pour souder acier, acier inox, cuivre, bronze, nickel
- Régulation continue du courant de soudure
- Protection thermostatique
- Prises professionnelles



Dotazione - Supplied with - Equipés avec



OPTIONAL

KIT MMA - DS 35



000205

Caratteristiche tecniche	Technical specifications	Données techniques		 DECATIG 200E
Alimentazione	Input voltage	Tension d'alimentation	Volt 50-60 Hz	1 Ph x 400
Fusibile di rete	Fuse	Fusible	Amp	32
Potenza d'installazione	Installation power	Puissance d'installation	KW 60%	15
Tensione a vuoto	Open circuit voltage	Tension à vide	Volt	70 AC 95 DC
Campo di regolazione	Welding current range	Champ de réglage	Amp	20 - 200 AC 15 - 180 DC
Elettrodi utilizzabili	Usable electrodes	Electrodes utilisables	Ø mm	TIG 1,6 - 3,2 MMA 1,6 - 4,0
Servizio	Duty cycle	Facteur de marche	Amp	200 @ 35% AC 180 @ 35% DC 150 @ 60% AC 135 @ 60% DC 120 @ 100% AC 110 @ 100% DC
Dimensioni	Dimensions	Dimensions	mm	890 x 460 x 800
Peso	Weight	Poids	≈kg.	100,0



MIG

Metal Inert Gas
Metal Active Gas
No Gas: Gasless Wire





LIGHT DUTY

STARFLUX 130 AC	Pag.	38
STARTWIN 135 EVO - 165/1 EVO - 180 E	Pag.	38
DECASTAR 130AC - 135EVO	Pag.	39
DECASTAR 150E - 180E	Pag.	39



PROFESSIONAL

D-mig 420 S - 420 T	Pag.	40
D-mig 520 S - 525 T	Pag.	42
D-mig Synergic 520 SD - 530 SD - 525 TD	Pag.	43



INDUSTRIAL

D-mig 635 T - 650 T - 660 T	Pag.	44
D-mig Synergic 635 TD - 650 TD - 660 TD	Pag.	45
D-mig Synergic 735 TD - 750 TD - 760 TD	Pag.	46



PROFESSIONAL

DECAMIG 2500 Synergic	Pag.	48
D-mig Synergic 530 TDK	Pag.	50
D-mig Synergic 532 TDK E	Pag.	51

STARFLUX • STARTWIN Series

MIG
LIGHT DUTY
TRADITIONAL

Caratteristiche

- **NO GAS:** questo sistema di saldatura utilizza uno speciale filo animato e non necessita di gas di protezione. È consigliato per effettuare saldature ad alta resistenza e saldature all'esterno anche in presenza di vento.
- **MIG MAG:** saldatura con gas di protezione Ar/CO₂ o CO₂
- Protezione termostatica

Features

- **NO GAS:** with this welding system a special selfshielded wire is used and no gas protection is needed. This system is suggested to obtain high welding penetration. It is ideal for outdoor welding.
- **MIG MAG:** welding with protective gas Ar/CO₂ or CO₂
- Overload protection

Caractéristiques

- **NO GAS:** ce système de soudage par l'emploi d'un fil spécial fourré n'exige pas de protection de gaz. Il est indiqué pour effectuer des soudures de haute résistance et pour les opérations de soudure à l'extérieur même en présence du vent
- **MIG MAG:** soudure avec gaz de protection Ar/CO₂ ou CO₂
- Protection thermostatique



1
PHASE



(STARTWIN 135EVO)

140A Valve

140A

OPTIONAL

Acciaio Steel Acier	Alluminio/Mg 5% Aluminium/Mg 5%	Inox Stainless Steel Acier Inoxidable	Animato Self-shielded Fourré
Ø 0,6 010871 (Blister) Ø 0,8 010872 (Blister)	Ø 0,8 010881 (Blister) Ø 1,0 010882 (Blister)	Ø 0,8 010892 (Blister)	Ø 0,9 010818 (Blister)

Dotazione - Supplied with - Equipés avec

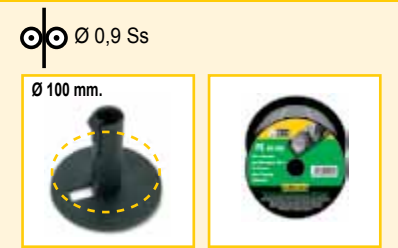

Caratteristiche tecniche	Technical specifications	Données techniques		STARFLUX 130AC NO GAS	STARTWIN 135 EVO	STARTWIN 165/1 EVO	STARTWIN 180E
Alimentazione	Input voltage	Tension d'alimentation	Volt 50-60 Hz	1 Ph x 230	1 Ph x 230	1 Ph x 230	1 Ph x 230
Fusibile di rete	Fuse	Fusible	Amp	16	16	16	16
Potenza d'installazione	Installation power	Puissance d'installation	KW 60%	1,0	1,5	1,7	2,5
Tensione a vuoto	Open circuit voltage	Tension à vide	Volt	22	30	30	34
Campo di regolazione	Welding current range	Champ de réglage	Amp (AR-CO ₂)	NO GAS 90 - 130	30 - 120	35 - 145	30 - 160
Servizio	Duty cycle	Facteur de marche	Amp	85 @ 25% 45 @ 90%	105 @ 15% 70 @ 35% 50 @ 60%	115 @ 15% 75 @ 35% 55 @ 60%	130 @ 20% 100 @ 35% 75 @ 60%
Posizioni di saldatura	Welding positions	Positions de soudure	N°	2	4	4	6
Dimensioni	Dimensions	Dimensions	mm	330 x 170 x 330	420 x 230 x 380		610 x 450 x 450
Peso	Weight	Poids	≈kg.	15,0	23,0	26,0	31,5
Filo utilizzabile	Weldable wire	Fil utilisable		Bobina - Spool - Bobine Ø mm. 100			
Filo acciaio	Steel wire	Fil acier	Ø mm	-	0,6 - 0,8	0,6 - 0,8	0,6 - 0,8
Filo inox	Stainless steel wire	Fil inox	Ø mm	-	0,8	0,8	0,8
Filo alluminio	Aluminium wire	Fil aluminium	Ø mm	-	0,8	0,8	0,8 - 1,0
Filo animato (acciaio)	Self shielded wire (mild steel)	Fil fourré (acier)	Ø mm	0,9	0,9	0,9	0,9

DECASTAR Series

MIG
LIGHT DUTY
TRADITIONAL

Caratteristiche

- **NO GAS:** questo sistema di saldatura utilizza uno speciale filo animato e non necessita di gas di protezione. È consigliato per effettuare saldature ad alta resistenza e saldature all'esterno anche in presenza di vento.
- **MIG MAG:** saldatura con gas di protezione Ar/CO₂ o CO₂
- Teleruttore per l'innesco e l'interruzione della corrente di saldatura (Decastar 150E - 180E)
- Protezione termostatica

Features

- **NO GAS:** with this welding system a special selfshielded wire is used and no gas protection is needed. This system is suggested to obtain high welding penetration. It is ideal for outdoor welding.
- **MIG MAG:** welding with protective gas Ar/CO₂ or CO₂
- Contactor for arc starting and welding current cut-off (Decastar 150E - 180E)
- Overload protection

Caractéristiques

- **NO GAS:** ce système de soudage par l'emploi d'un fil spécial fourré n'exige pas de protection de gaz. Il est indiqué pour effectuer des soudures de haute résistance et pour les opérations de soudure à l'extérieur même en présence du vent
- **MIG MAG:** soudure avec gaz de protection Ar/CO₂ ou CO₂
- Contacteur permettant l'amorçage de l'arc et l'interruption de la courant de soudure (Decastar 150E - 180E)
- Protection thermostatique



(DECASTAR 150E)

160A



140A Valve

140A



1
PHASE



CE



OPTIONAL

Acciaio Steel Acier	Alluminio/Mg 5% Aluminium/Mg 5%	Inox Stainless Steel Acier Inoxidable	Animato Self-shielded Fourré
Ø 0,6 010871 (Blister) Ø 0,8 010872 (Blister)	Ø 0,8 010881 (Blister) Ø 1,0 010882 (Blister)	Ø 0,8 010892 (Blister)	Ø 0,9 010818 (Blister)

Dotazione - Supplied with - Equipés avec

Ø 0,6 Fe*
Ø 0,9 Ss

*Eccetto - Except - Sauf Decastar 130AC



Caratteristiche tecniche	Technical specifications	Données techniques		DECASTAR 130AC NO GAS	DECASTAR 135EVO	DECASTAR 150E	DECASTAR 180E
Alimentazione	Input voltage	Tension d'alimentation	Volt 50-60 Hz	1 Ph x 230	1 Ph x 230	1 Ph x 230	1 Ph x 230
Fusibile di rete	Fuse	Fusible	Amp	16	16	16	16
Potenza d'installazione	Installation power	Puissance d'installation	KW 60%	1,0	1,5	1,7	2,5
Tensione a vuoto	Open circuit voltage	Tension à vide	Volt	22	30	30	34
Campo di regolazione	Welding current range	Champ de réglage	Amp (AR-CO ₂)	NO GAS 90 - 130	35 - 120	30 - 145	35 - 160
Servizio	Duty cycle	Facteur de marche	Amp	85 @ 25% 45 @ 90%	105 @ 15% 70 @ 35%	115 @ 15% 75 @ 35%	130 @ 20% 100 @ 35%
Posizioni di saldatura	Welding positions	Positions de soudure	N°	2	4	4	6
Dimensioni	Dimensions	Dimensions	mm	330 x 170 x 330	420 x 230 x 380	610 x 450 x 450	
Peso	Weight	Poids	≈kg.	15,0	23,0	30,0	31,5
Filo utilizzabile	Weldable wire	Fil utilisable		Ø 100 mm. Bobina - Spool - Bobine Ø mm. 100-200			
Filo acciaio	Steel wire	Fil acier	Ø mm	-	0,6 - 0,8	0,6 - 0,8	0,6 - 0,8
Filo inox	Stainless steel wire	Fil inox	Ø mm	-	0,8	0,8	0,8
Filo alluminio	Aluminium wire	Fil aluminium	Ø mm	-	0,8	0,8 - 1,0	0,8 - 1,0
Filo animato (acciaio)	Self shielded wire (mild steel)	Fil fourré (acier)	Ø mm	0,9	0,9	0,9	0,9



D-mig 400 Series

MIG
PROFESSIONAL
TRADITIONAL

Caratteristiche

- Saldatura continua manuale (2 tempi)
- Protezione termostatica
- Interruttore ON/OFF per poter spegnere la macchina senza muovere le regolazioni di potenza
- Saldatrice carrellata
- Dotate di torcia con attacco Euro

Features

- Manual wire feed welding (2 steps)
- Overload protection
- ON/OFF switch to turn off the machine without changing the power adjustment
- Wheeled welder
- Equipped with Euro connection torch

Caractéristiques

- Soudure en continu manuelle (à 2 temps)
- Protection thermostatique
- Interrupteur ON/OFF pour débrancher le poste à souder sans déplacer les réglages de puissance
- Poste à souder sur roues
- Dotés de torche avec connecteur Euro



1
PHASE

3
PHASE



CE



OPTIONAL

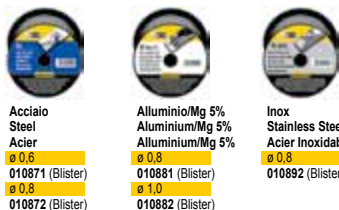

BOBINA
SPOOL
BOBINE

Ø 100/200 mm.



Acciaio
Steel
Acier
Ø 0,6
010871 (Blister)
Ø 0,8
010872 (Blister)

Alluminio/Mg 5%
Aluminium/Mg 5%
Aluminium/Mg 5%
Ø 0,8
010881 (Blister)
Ø 1,0
010882 (Blister)

Inox
Stainless Steel
Acier Inoxidable
Ø 0,8
010892 (Blister)

Dotazione - Supplied with - Equipés avec

Ø 0,6 Fe
Ø 0,8 Fe



Caratteristiche tecniche	Technical specifications	Données techniques		1 PHASE D-mig 420 S	3 PHASE D-mig 420 T
Alimentazione	Input voltage	Tension d'alimentation	Volt 50-60 Hz	1 Ph x 230	3 Ph x 400
Fusibile di rete	Fuse	Fusible	Amp	20	6
Potenza d'installazione	Installation power	Puissance d'installation	KW 60%	2,5	2,5
Tensione a vuoto	Open circuit voltage	Tension à vide	Volt	33	33
Campo di regolazione	Welding current range	Champ de réglage	Amp (AR-CO₂)	35 - 200	20 - 160
Servizio	Duty cycle	Facteur de marche	Amp	180 @ 15% 100 @ 60% 80 @ 100%	140 @ 25% 100 @ 60% 80 @ 100%
Posizioni di saldatura	Welding positions	Positions de soudure	N°	6	7
Dimensioni	Dimensions	Dimensions	mm	410 x 710 x 540	
Peso	Weight	Poids	≈kg.	39,0	37,0
Filo utilizzabile	Weldable wire	Fil utilisable		Bobina - Spool - Bobine Ø mm. 200 - 300	
Filo acciaio	Steel wire	Fil acier	Ø mm	0,6 - 1,0	0,6 - 1,0
Filo inox	Stainless steel wire	Fil inox	Ø mm	0,8	0,8
Filo alluminio	Aluminium wire	Fil aluminium	Ø mm	0,8 - 1,0	0,8 - 1,0

D-mig Synergic Digital Control

Il controllo MIG Synergic facilita il lavoro del saldatore gestendo in sinergia con le altre impostazioni della saldatrice, la velocità del filo, la rampa iniziale ed il burn back. Il saldatore deve soltanto attivare uno dei programmi preimpostati. Il controllo MIG Synergic, è attivo con tutte le torce previste per la saldatrice.

The Synergic MIG control facilitates the welding machine operator's work as it manages wire speed, soft start and burn back in a synergic way with the rest of the machine settings. The welding machine operator must simply activate one of the pre-set programs. The Synergic MIG control is active with all the torches provided for the welding machine.

Le contrôle MIG Synergic facilite le travail du soudeur en gérant en synergie avec les autres configurations de la soudeuse, la vitesse du fil, la rampe initiale et le burn back. Le soudeur doit uniquement enclencher un des programmes préconfigurés. Le contrôle MIG Synergic est actif sur toutes les torches prévues pour la soudeuse.



Caratteristiche

- 1) **Selezione tipo di filo***
• Fe / Al / CuSi3 / Flux
- 2) **Selezione diametro filo***
• 0,6 / 0,8 / 1,0 / 1,2 / 1,6
- 3) **Selezione tipo di gas**
• Argon / Argon CO₂ / CO₂
- 4) **Selezione modalità di saldatura:**
• 2 tempi (2T) / 4 tempi (4T)
- 5) **Selezione modalità di saldatura:**
• Manuale / Sinergica
- 6) **Selezione modalità di saldatura:**
• Continua / Spot (puntatura) / Stitch (tratteggio)
- 7) **Accesso al sottomenu:**
• Burn Back / Rampa Soft Start / Tempo di pausa per la modalità stitch
- 8) **Regolazione fine della velocità del filo (+/- 20%) impostato dalla sinergia**
- Regolazione della velocità del filo in posizione manuale
- 9) **Amperometro / Voltmetro digitale**
- **Funzione caricamento filo**

* Valori differenti a seconda dei modelli

Features

- 1) **Type wire selection***
• Fe / Al / CuSi3 / Flux
 - 2) **Diameter wire selection***
• 0,6 / 0,8 / 1,0 / 1,2 / 1,6
 - 3) **Gas type selection**
• Argon / Argon CO₂ / CO₂
 - 4) **Welding mode selection:**
• (2T - 4T)
 - 5) **Manual / synergic welding selection**
 - 6) **Welding mode selection:**
• Continuous / Spot / Stitch
 - 7) **Menu access:**
• Burn Back / Soft Start / Pause time in stitch mode
 - 8) **Fine wire speed regulation (+/- 20%) set by synergy**
- Wire speed regulation in manual setting
 - 9) **Digital Ammeter / Voltmeter**
 - **Wire loading function**
- * Different values depending on the model

Caractéristiques

- 1) **Selection types du fil***
• Fe / Al / CuSi3 / Flux
 - 2) **Selection diametre du fil***
• 0,6 / 0,8 / 1,0 / 1,2 / 1,6
 - 3) **Selection du gas**
• Argon / Argon CO₂ / CO₂
 - 4) **Selection soudure:**
• (2T - 4T)
 - 5) **Selection soudure:**
• Manuelle / Sinergic
 - 6) **Selection soudure:**
• Continu / Spot / Stitch
 - 7) **Enter menu additionelle:**
• Burn Back / Soft Start / Temp de pause en mode stitch
 - 8) **Réglage fin du vitesse du fil (+/- 20%) établi par la sinergie.**
- Réglage du vitesse du fil en position manuelle.
 - 9) **Ampèremètre Voltmètre digitale**
 - **Fonction chargement de fil**
- * Valeurs différentes selon le modèle

D-mig 500 Series

MIG
PROFESSIONAL
TRADITIONAL

Caratteristiche

- Per la saldatura del filo acciaio, alluminio MG e Si, CuSi3/CuAl (MIG BRAZING) da utilizzare sui nuovi acciai duri HSS, EHS, UHS, ACCIAIO BORO.
- Saldatura continua manuale (2 tempi)
- Saldatura a punti: offre la possibilità di eseguire punti di unione su lamiere sovrapposte accessibili da un solo lato.
- Burn back regolabile: evita l'incollaggio del filo.
- Soft start regolabile per ottenere un innesco d'arco fluido
- Interruttore ON/OFF per poter spegnere la macchina senza muovere le regolazioni di potenza
- Protezione termostatica
- Dotate di porta torcia

Features

- For mild steel solid wire or mig braze-wire Cu Si3 / Cu Al (MIG BRAZING) to weld HSS, EHS, UHS and BORO STEEL, aluminium Mg / Si.
- Manual wire feed welding (2 steps)
- Spot welding: gives the possibility of welding two overlapped metal sheets with welding spots, when having access only from one side
- Adjustable burnback: eliminates the sticking of the welding wire,
- Adjustable soft start. This result is a smooth welding arc start
- ON/OFF switch to turn off the machine without changing the power adjustment
- Overload protection
- Equipped with torch holder

Caractéristiques

- Pour souder le fil acier ms ou fil Cu Si3/ Cu Al (MIG BRAZING) à utiliser avec l'ACIER HSS, EHS, UHS et l'ACIER BORO, aluminium Mg / Si.
- Soudure en continu manuelle (à 2 temps)
- Soudure par points: il est possible d'exécuter des points de soudure sur tôles se recouvrant et accessibles d'un seul côté
- Burnback réglable: pas de collage du fil.
- Soft start réglable. On obtient ainsi un amorçage d'arc fluide
- Interrupteur ON/OFF pour débrancher le poste à souder sans déplacer les réglages de puissance
- Protection thermostatique.
- Equipé d'un soutien pour la torche



3
PHASE

BRAZING

TURBO

CE

PG



OPTIONAL

BOBINA
SPOOL
BOBINE

Ø 100/200 mm.



Dotazione - Supplied with - Equipés avec

TORCH HOLDER



Ø 0,6 Fe
Ø 0,8 Fe



180A



Caratteristiche tecniche	Technical specifications	Données techniques		D-mig 520 T	D-mig 525 T
Alimentazione	Input voltage	Tension d'alimentation	Volt 50-60 Hz	3 Ph x 230/400	3 Ph x 230/400
Fusibile di rete	Fuse	Fusible	Amp	16/10	16/10
Potenza d'installazione	Installation power	Puissance d'installation	KW 60%	3,5	5,5
Tensione a vuoto	Open circuit voltage	Tension à vide	Volt	34	33
Campo di regolazione	Welding current range	Champ de réglage	Amp (AR-CO ₂)	20 - 190	20 - 220
Servizio	Duty cycle	Facteur de marche	Amp	150 @ 30% 105 @ 60% 85 @ 100%	180 @ 50% 160 @ 60% 125 @ 100%
Posizioni di saldatura	Welding positions	Positions de soudure	N°	7	7
Dimensioni	Dimensions	Dimensions	mm	505 x 840 x 765	
Peso	Weight	Poids	≈kg.	48,5	52,0
Filo utilizzabile	Weldable wire	Fil utilisabile		Bobina - Spool - Bobine Ø mm. 200 - 300	
Filo acciaio	Steel wire	Fil acier	Ø mm	0,6 - 1,0	0,6 - 1,0
Filo inox	Stainless steel wire	Fil inox	Ø mm	0,8 - 1,0	0,8 - 1,0
Filo alluminio	Aluminium wire	Fil aluminium	Ø mm	0,8 - 1,0	0,8 - 1,0
Filo CuSi 3- CuAl	CuSi 3- CuAl wire	Fil CuSi 3- CuAl	Ø mm	0,8 - 1,0	0,8 - 1,0

D-mig 500 Synergic Series

MIG
PROFESSIONAL
TRADITIONAL

Caratteristiche

- Dotate di tecnologia sinergica digitale **SIMPLE WELD** (pag. 41)
- Per la saldatura del filo acciaio, alluminio MG e Si, CuSi3/CuAl (MIG BRAZING) da utilizzare sui nuovi acciai duri HSS, EHS, UHS, ACCIAIO BORO.
- Interruttore ON/OFF per poter spegnere la macchina senza muovere le regolazioni di potenza
- Protezione termica
- Dotate di porta torcia

Features

- Equipped with **SIMPLE WELD** digital synergic technology (pag. 41)
- For mild steel solid wire or mig braze-wire Cu Si3 / Cu Al (MIG BRAZING) to weld HSS, EHS, UHS and BORO STEEL, aluminium Mg / Si.
- ON/OFF switch to turn off the machine without changing the power adjustment
- Overload protection
- Equipped with torch holder

Caractéristiques

- Dotés de technologie sinergic digital **SIMPLE WELD** (pag. 41)
- Pour souder le fil acier ms ou fil Cu Si3/ Cu Al (MIG BRAZING) à utiliser avec l'ACIER HSS, EHS, UHS et l'ACIER BORO, aluminium Mg / Si.
- Interrupteur ON/OFF pour débrancher le poste à souder sans déplacer les réglages de puissance
- Protection thermique
- Equipé d'un soutien pour la torche



1
PHASE

3
PHASE

SIMPLE WELD

SYNERGIC

BRAZING

TURBO

CE

PG



SIMPLE WELD

OPTIONAL

BOBINA
SPOOL
BOBINE

Ø 100/200 mm.



Dotazione - Supplied with - Equipés avec

TORCH HOLDER



Ø 0,6 Fe
Ø 0,8 Fe



180A



Caratteristiche tecniche	Technical specifications	Données techniques		1 PHASE	1 PHASE	3 PHASE
				D-mig 520 SD	D-mig 530 SD	D-mig 525 TD
Alimentazione	Input voltage	Tension d'alimentation	Volt 50-60 Hz	1 Ph x 230	1 Ph x 230	3 Ph x 230/400
Fusibile di rete	Fuse	Fusible	Amp	16	25	16/10
Potenza d'installazione	Installation power	Puissance d'installation	KW 60%	2	4	5,5
Tensione a vuoto	Open circuit voltage	Tension à vide	Volt	34	39	33
Campo di regolazione	Welding current range	Champ de réglage	Amp (AR-CO ₂)	25 - 180	30 - 240	20 - 220
Servizio	Duty cycle	Facteur de marche	Amp	150 @ 20% 90 @ 60% 75 @ 100%	210 @ 15% 125 @ 60% 95 @ 100%	180 @ 50% 160 @ 60% 125 @ 100%
Posizioni di saldatura	Welding positions	Positions de soudure	N°	6	6	7
Dimensioni	Dimensions	Dimensions	mm	505 x 840 x 765		
Peso	Weight	Poids	≈kg.	47,5	57,0	52,0
Filo utilizzabile	Weldable wire	Fil utilisable		Bobina - Spool - Bobine Ø mm. 200 - 300		
Filo acciaio	Steel wire	Fil acier	Ø mm	0,6 - 1,0	0,6 - 1,0	0,6 - 1,0
Filo inox	Stainless steel wire	Fil inox	Ø mm	0,8 - 1,0	0,8 - 1,0	0,8 - 1,0
Filo alluminio	Aluminium wire	Fil aluminium	Ø mm	0,8 - 1,0	0,8 - 1,0	0,8 - 1,0
Filo CuSi 3- CuAl	CuSi 3- CuAl wire	Fil CuSi 3- CuAl	Ø mm	0,8 - 1,0	0,8 - 1,0	0,8 - 1,0



D-mig 600 Series

MIG
INDUSTRIAL
TRADITIONAL

Caratteristiche

- Per la saldatura del filo acciaio, alluminio MG e Si
- Trainafile a quattro rulli ingranati.
- Saldatura continua manuale (2 tempi) ed automatica (4 tempi)
- Saldatura a punti.
- Burnback automatico: (possibile una regolazione dall'interno macchina).
- Soft start automatico: (possibile una regolazione dall'interno macchina).
- Interruttore ON/OFF
- Protezione termostatica.
- Dotate di porta torcia.

Features

- For mild steel solid wire, aluminium Mg / Si
- 4 rollers wire feed device
- Manual wire feed welding (2 steps) and automatic (4 steps)
- Spot welding.
- Automatic burnback: (possibility of adjustment from inside the machine).
- Automatic soft start: (possibility of adjustment from inside the machine).
- ON/OFF switch.
- Overload protection.
- Equipped with torch holder.

Caractéristiques

- Pour souder le fil acier, aluminium Mg / Si
- Dévidoir à 4 rouleaux.
- Soudure en continu manuelle (à 2 temps) et automatique (à 4 temps)
- Soudure par points.
- Burnback automatique: (possibilité de réglage de l'intérieur du poste).
- Soft start automatique: (possibilité de réglage de l'intérieur du poste).
- Interrupteur ON/OFF
- Protection thermostatique.
- Equipé d'un soutien pour la torche.



3
PHASE

4
ROLLERS

TURBO

CE

PC



Dotazione - Supplied with - Equipés avec

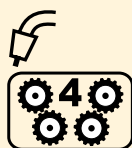

Trainafile a 4 rulli ingranati
4 rollers wire feed device
Dévidoir à 4 rouleaux

TORCH HOLDER



D-mig 635 T	✓	✓	-
D-mig 650 T	✓	-	✓
D-mig 660 T	✓	-	✓

Ø 0,8 Fe
Ø 1,0 Fe
Ø 1,2 Fe
Ø 1,6 Fe



Caratteristiche tecniche	Technical specifications	Données techniques		D-mig 635 T	D-mig 650 T	D-mig 660 T
Alimentazione	Input voltage	Tension d'alimentation	Volt 50-60 Hz	3 Ph x 230/400	3 Ph x 230/400	3 Ph x 230/400
Fusibile di rete	Fuse	Fusible	Amp	25/16	32/25	50/32
Potenza d'installazione	Installation power	Puissance d'installation	KW 60%	8,5	15	15
Tensione a vuoto	Open circuit voltage	Tension à vide	Volt	16,7 - 39,5	17 - 48	16,8 - 48
Campo di regolazione	Welding current range	Champ de réglage	Amp (AR-CO ₂)	25 - 350	25 - 500	25 - 600
Servizio	Duty cycle	Facteur de marche	Amp	350 @ 25% 210 @ 60% 180 @ 100%	500 @ 25% 335 @ 60% 270 @ 100%	600 @ 25% 375 @ 60% 315 @ 100%
Posizioni di saldatura	Welding positions	Positions de soudure	N°	10	21	30
Dimensioni	Dimensions	Dimensions	mm	870 x 540 x 1020	870 x 540 x 1020	870 x 540 x 1020
Peso	Weight	Poids	≈kg.	96,5	123,5	135,5
Filo utilizzabile	Weldable wire	Fil utilisable		Bobina - Spool - Bobine Ø mm. 200 - 300		
Filo acciaio	Steel wire	Fil acier	Ø mm	0,8 - 1,6	0,8 - 1,6	0,8 - 1,6
Filo inox	Stainless steel wire	Fil inox	Ø mm	0,8 - 1,6	0,8 - 1,6	0,8 - 1,6
Filo alluminio	Aluminium wire	Fil aluminium	Ø mm	1,0 - 1,6	1,0 - 1,6	1,0 - 1,6
Filo animato (acciaio)	Self shielded wire (mild steel)	Fil fourré (acier)	Ø mm	1,2 - 1,6	1,2 - 1,6	1,2 - 1,6

D-mig 600 Synergic Series

MIG
INDUSTRIAL
TRADITIONAL

Caratteristiche

- Dotate di tecnologia sinergica digitale **SIMPLE WELD** (pag. 41)
- Amperometro / Voltmetro digitale
- **Per la saldatura del filo acciaio, alluminio MG e Si**
- Trainafilo a 4 rulli ingranati
- Interruttore ON/OFF per poter spegnere la macchina senza muovere le regolazioni di potenza
- Protezione termica
- Dotate di porta torcia

Features

- Equipped with **SIMPLE WELD** digital synergic technology (pag. 41)
- Digital Ammeter / Voltmeter
- **For mild steel solid wire, aluminium Mg / Si**
- 4 rollers wire feed device
- ON/OFF switch to turn off the machine without changing the power adjustment
- Overload protection
- Equipped with torch holder

Caractéristiques

- Dotés de technologie sinergic digital **SIMPLE WELD** (pag. 41)
- Ampèremètre / Voltmètre digitale
- **Pour souder le fil acier, aluminium Mg / Si**
- Dévidoir à 4 rouleaux
- Interrupteur ON/OFF pour débrancher le poste à souder sans déplacer les réglages de puissance
- Protection thermique
- Equipé d'un soutien pour la torche



- 3**
PHASE
- SIMPLE WELD**
- SYNERGIC**
- 4**
ROLLERS
- TURBO**
- CE**
- PG**

AMP/VOLT
20.2A 20.0V

SIMPLE WELD

Dotazione - Supplied with - Equipés avec

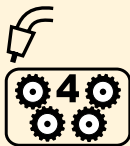

Trainafilo a 4 rulli ingranati
4 rollers wire feed device
Dévidoir à 4 rouleaux

TORCH HOLDER



D-mig 635 TD	✓	✓	-
D-mig 650 TD	✓	-	✓
D-mig 660 TD	✓	-	✓

Ø 0,8 Fe
Ø 1,0 Fe
Ø 1,2 Fe
Ø 1,6 Fe



Caratteristiche tecniche	Technical specifications	Données techniques		D-mig 635 TD	D-mig 650 TD	D-mig 660 TD
Alimentazione	Input voltage	Tension d'alimentation	Volt 50-60 Hz	3 Ph x 230/400	3 Ph x 230/400	3 Ph x 230/400
Fusibile di rete	Fuse	Fusible	Amp	25/16	32/25	50/32
Potenza d'installazione	Installation power	Puissance d'installation	KW 60%	8,5	15	15
Tensione a vuoto	Open circuit voltage	Tension à vide	Volt	16,7 - 39,5	17 - 48	16,8 - 48
Campo di regolazione	Welding current range	Champ de réglage	Amp (AR-CO₂)	25 - 350	25 - 500	25 - 600
Servizio	Duty cycle	Facteur de marche	Amp	350 @ 25% 210 @ 60% 180 @ 100%	500 @ 25% 335 @ 60% 270 @ 100%	600 @ 25% 375 @ 60% 315 @ 100%
Posizioni di saldatura	Welding positions	Positions de soudure	N°	10	21	30
Dimensioni	Dimensions	Dimensions	mm	870 x 540 x 1020	870 x 540 x 1020	870 x 540 x 1020
Peso	Weight	Poids	≈kg.	96,5	123,5	135,5
Filo utilizzabile	Weldable wire	Fil utilisable		Bobina - Spool - Bobine Ø mm. 200 - 300		
Filo acciaio	Steel wire	Fil acier	Ø mm	0,8 - 1,6	0,8 - 1,6	0,8 - 1,6
Filo inox	Stainless steel wire	Fil inox	Ø mm	0,8 - 1,6	0,8 - 1,6	0,8 - 1,6
Filo alluminio	Aluminium wire	Fil aluminium	Ø mm	1,0 - 1,6	1,0 - 1,6	1,0 - 1,6
Filo animato (acciaio)	Self shielded wire (mild steel)	Fil fourré (acier)	Ø mm	1,2 - 1,6	1,2 - 1,6	1,2 - 1,6



D-mig 700 Series



D-MIG 700 - WF 4

Caratteristiche

- Per la saldatura del filo acciaio, alluminio MG e Si
- Trainafilo a quattro rulli ingranati, ideale per fili animati, grossi diametri, fili di alluminio.
- Saldatura continua manuale (2 tempi) ed automatica (4 tempi)
- Saldatura a punti
- Burnback automatico: (possibile una regolazione dall'interno carrello)
- Soft start automatico: (possibile una regolazione dall'interno carrello)
- Interruttore ON/OFF per poter spegnere la macchina senza muovere le regolazioni di potenza
- Protezione termica
- Predisposizione per raffreddamento torcia ad acqua

Features

- For mild steel solid wire, aluminium Mg / Si
- 4 rollers wire feed device, ideal for large diameters, selfshielded wires.
- Manual wire feed welding (2 steps) and automatic (4 steps)
- Spot welding
- Automatic burnback: (possibility of adjustment from inside the wire feed unit)
- Automatic soft start: (possibility of adjustment from inside the wire feed unit)
- ON/OFF switch to turn off the machine without changing the power adjustment
- Overload protection
- Equipped for torch water cooling system

Caractéristiques

- Pour souder le fil acier, aluminium Mg / Si
- Doté de dévidoir à 4 rouleaux, idéal pour fil fourrés, grand diamètre.
- Soudure en continu manuelle (à 2 temps) et automatique (à 4 temps)
- Soudure par points
- Burnback automatique: (possibilité de réglage de l'intérieur du dévidoir)
- Soft start automatique: (possibilité de réglage de l'intérieur du dévidoir)
- Interrupteur ON/OFF pour débrancher le poste à souder sans déplacer les réglages de puissance
- Protection thermostatique
- Logement pour groupe des refroidissement par eau

D-MIG 700 - WF 4D Synergic

Caratteristiche

- Per la saldatura del filo acciaio, alluminio MG e Si
- Dotate di tecnologia sinergica digitale SIMPLE WELD (pag. 41)
- Amperometro / Voltmetro digitale
- Trainafilo a quattro rulli ingranati, ideale per fili animati, grossi diametri, fili di alluminio.
- Interruttore ON/OFF per poter spegnere la macchina senza muovere le regolazioni di potenza
- Protezione termica
- Predisposizione per raffreddamento torcia ad acqua
- Dotate di porta torcia

Features

- For mild steel solid wire, aluminium Mg / Si
- Equipped with SIMPLE WELD digital synergic technology (pag. 41)
- Digital Ammeter / Voltmeter
- 4 rollers wire feed device, ideal for large diameters, selfshielded wires.
- ON/OFF switch to turn off the machine without changing the power adjustment
- Overload protection
- Equipped for torch water cooling system
- Equipped with torch holder

Caractéristiques

- Pour souder le fil acier, aluminium Mg / Si
- Dotés de technologie sinergic digital SIMPLE WELD (pag. 41)
- Ampèremètre / Voltmètre digitale
- Doté de dévidoir à 4 rouleaux, idéal pour fil fourrés, grand diamètre.
- Interrupteur ON/OFF pour débrancher le poste à souder sans déplacer les réglages de puissance
- Protection thermique
- Logement pour groupe des refroidissement par eau
- Equipé d'un soutien pour la torche



AMP/VOLT
202A 20.0V

SIMPLE WELD

Caratteristiche tecniche	Technical specifications	Données techniques		D-MIG 735 TD	D-MIG 750 TD	D-MIG 760 TD
Alimentazione	Input voltage	Tension d'alimentation	Volt 50-60 Hz	3 Ph x 230/400	3 Ph x 230/400	3 Ph x 230/400
Fusibile di rete	Fuse	Fusible	Amp	25/16	32/25	50/32
Potenza d'installazione	Installation power	Puissance d'installation	KW 60%	8,5	15	15
Tensione a vuoto	Open circuit voltage	Tension à vide	Volt	16,7 - 39,5	17 - 48	16,8 - 48
Campo di regolazione	Welding current range	Champ de réglage	Amp (AR-CO ₂)	25 - 350	25 - 500	25 - 600
Servizio	Duty cycle	Facteur de marche	Amp	350 @ 25% 210 @ 60% 180 @ 100%	500 @ 25% 335 @ 60% 270 @ 100%	600 @ 25% 375 @ 60% 315 @ 100%
Posizioni di saldatura	Welding positions	Positions de soudure	N°	10	21	30
Dimensioni	Dimensions	Dimensions	≈mm	915 x 540 x 1365	915 x 540 x 1365	915 x 540 x 1365
Peso	Weight	Poids	≈kg.	86,5 WF4D Kg. 21,5 / WF4 Kg.13,0	112,3 WF4D Kg. 21,5 / WF4 Kg.13,0	126,4 WF4D Kg. 21,5 / WF4 Kg.13,0
Filo utilizzabile	Weldable wire	Fil utilisable		Bobina - Spool - Bobine Ø mm. 200 - 300		
Filo acciaio	Steel wire	Fil acier	Ø mm	0,8 - 1,6	0,8 - 1,6	0,8 - 1,6
Filo inox	Stainless steel wire	Fil inox	Ø mm	0,8 - 1,6	0,8 - 1,6	0,8 - 1,6
Filo alluminio	Aluminium wire	Fil aluminium	Ø mm	1,0 - 1,6	1,0 - 1,6	1,0 - 1,6
Filo animato (acciaio)	Self shielded wire (mild steel)	Fil fourré (acier)	Ø mm	1,2 - 1,6	1,2 - 1,6	1,2 - 1,6



WF 4

WF 4D

WF 4

WF 4D

WF 4

WF 4D

D-mig 735TD

D-mig 750TD

D-mig 760TD



Cavi intermedi
Intermediary cables
Liason generateur/devidoir
3m 010142 (1 pc)
4m 010138 (1 pc)
9m 010144 (1 pc)



Cavi intermedi
Intermediary cables
Liason generateur/devidoir
3m 010142 (1 pc)
4m 010138 (1 pc)
9m 010144 (1 pc)



Cavi intermedi
Intermediary cables
Liason generateur/devidoir
3m 010142 (1 pc)
4m 010138 (1 pc)
9m 010144 (1 pc)

230A



010236

340A



010463

340A

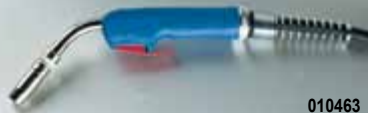

010463

D-MIG 700TD H₂O (standard components)



WU 1500

Impianto di raffreddamento
Water cooling unit
Unité de refroidissement
010651



Cavi intermedi
Intermediary cables
Liason generateur/devidoir
H₂O 3m 010143 (1 pc)
H₂O 4m 010139 (1 pc)
H₂O 9m 010145 (1 pc)



CO₂ / Ar+CO₂
500A H₂O /3m 500/450A @ 100% 010461 (1 pc)
500A H₂O /4m 500/450A @ 100% 010462 (1 pc)

OPTIONAL



**Kit Wheels
WF4**

010067

Dotazione - Supplied with - Equipés avec



**WF 4
WF 4D**

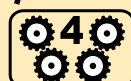

Trainafilo a 4 rulli ingranati
4 rollers wire feed device
Dévidoir à 4 rouleaux

TORCH HOLDER



Ø 0,8 Fe
Ø 1,0 Fe
Ø 1,2 Fe
Ø 1,6 Fe



DECAMIG 2500



MIG
PROFESSIONAL

INVERTER



1
PHASE

SYNERGIC

GENERATOR

TURBO

CE



Caratteristiche

La sinergia, gestita da un potente microprocessore, tramite la variazione della sola velocità del filo, regola autonomamente i parametri di saldatura. L'operatore deve unicamente selezionare il metallo ed il diametro del filo.

La sinergia è escudibile (posizione manuale) per poter gestire liberamente tutti i parametri di saldatura.

Il modello gestisce, oltre alla torcia tradizionale, la torcia SPOOL GUN e la torcia con regolazione del filo sull'impugnatura.

Le speciali caratteristiche dinamiche di questo generatore, sfruttate attraverso questi accessori, rendono facile la saldatura dell'alluminio al silicio ed al magnesio.

- Per la saldatura del filo acciaio, alluminio MG e Si, CuSi3/CuAl (MIG BRAZING) da utilizzare sui nuovi acciai duri HSS, EHS, UHS, ACCIAIO BORO.

Features

Synergy, controlled by a powerful microprocessor, thanks to the wire speed change, automatically sets the welding parameters. The operator shall only select metal and wire diameter. Synergy may be cut out (manual setting) in order to freely manage all welding parameters.

The model may use, besides to traditional torch, SPOOL GUN torch and torch with handle wire speed regulation. The special dynamic features of the power source, together with these accessories, do optimize aluminium Si/Mg welding.

- For mild steel solid wire or mig braze-wire Cu Si3 / Cu Al (MIG BRAZING) to weld HSS, EHS, UHS and BORO STEEL, aluminium Mg / Si.

Caractéristiques

La sinergie, gérée par un puissant microprocesseur, seulement grâce à la variation de la vitesse du fil, règle automatiquement les paramètres de soudure. L'utilisateur doit tout simplement sélectionner le type de métal et le diamètre du fil.

La sinergie est excluable (position manuelle) pour pouvoir gérer librement tous les paramètres de soudure.

Le modèle peut utiliser, en plus de la torche traditionnelle, la torche SPOOL GUN et la torche avec réglage de la vitesse du fil sur la poignée. Les caractéristiques dynamiques spéciales de ce générateur, exploitées pour le mieux grâce à ces accessoires, simplifient la soudure de l'aluminium Si/Mg.

- Pour souder le fil acier ms ou fil Cu Si3/ Cu Al (MIG BRAZING) à utiliser avec l'ACIER HSS, EHS, UHS et l'ACIER BORO, aluminium Mg / Si.



GENERATOR
OUTPUT-VOLTAGE
+/- 30%

OPTIONAL

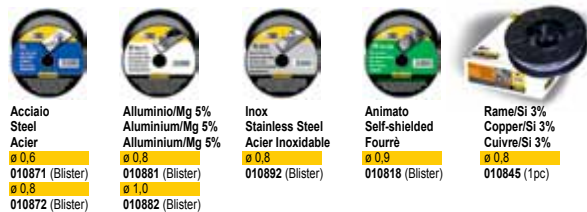

Dotazione - Supplied with - Equipés avec

Ø 0,6 Fe
Ø 0,8 Fe
Ø 0,9 Ss



Caratteristiche tecniche	Technical specifications	Données techniques	DECAMIG 2500 Synergic	
Alimentazione	Input voltage	Tension d'alimentation	1 Ph x 230	
Fusibile di rete	Fuse	Fusible	20	
Potenza d'installazione	Installation power	Puissance d'installation	4,5	
Tensione a vuoto	Open circuit voltage	Tension à vide	45	
Campo di regolazione	Welding current range	Champ de réglage	Amp (AR-CO ₂) 15 - 190	
Servizio	Duty cycle	Facteur de marche	Amp 190 @ 25% 160 @ 60% 145 @ 100%	
Posizioni di saldatura	Welding positions	Positions de soudure	N° 11 Synergic + 1 manual	
Dimensioni	Dimensions	Dimensions	mm 430 x 270 x 430	
Peso	Weight	Poids	≈kg. 18,0	
Filo utilizzabile	Weldable wire	Fil utilisable	Bobina - Spool - Bobine Ø mm. 100-200	
			Synergic Program	Manual Program
Filo acciaio	Steel wire	Fil acier	Ø mm 0,6 - 0,8	0,6 - 0,8 - 1,0
Filo inox	Stainless steel wire	Fil inox	Ø mm 0,8	0,8 - 1,0
Filo alluminio	Aluminium wire	Fil aluminium	Ø mm 0,8 - 1,0	0,8 - 1,0
Filo CuSi 3- CuAl	CuSi 3- CuAl wire	Fil CuSi 3- CuAl	Ø mm 0,8	0,8 - 1,0
Filo animato (acciaio)	Self shielded wire (mild steel)	Fil fourré (acier)	Ø mm 0,9	0,9



Synergic Control

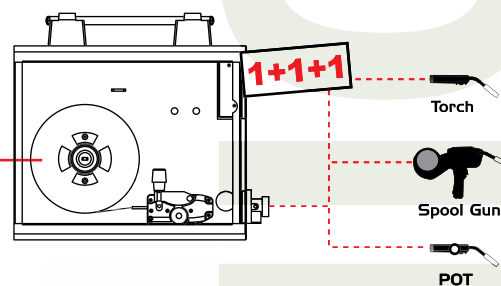
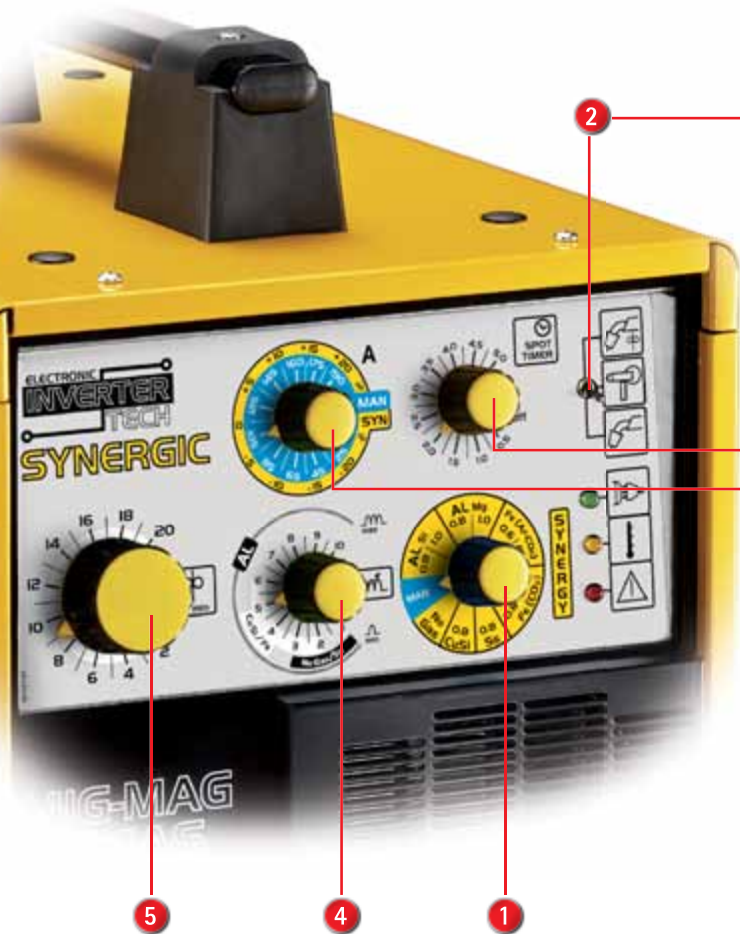

Caratteristiche

- 11 programmi preimpostati** consentono a saldatura di tutti i metalli più comuni quali:
 - alluminio al Silicio
 - alluminio al Magnesio
 - acciaio comune
 - acciaio zincato
 - acciaio inox
 - acciai duri e la saldatura dell'acciaio con filo animato senza gas di protezione.**1 programma manuale per tutti i fili e diametri.**
- Tre tipi di torcia con attacco Euro:**
 - a) Torcia standard consigliata per fili acciaio ramato, acciaio al titanio, acciaio inox e animato no-gas
 - b) Torcia spool gun con regolazione della sinergia sull'impugnatura, indispensabile per fili alluminio al Silicio (Si) e Magnesio (Mg).
 - c) Torcia con regolazione della sinergia sull'impugnatura indicata per il filo da saldobrasatura CuSi-CuAl per lamiere zincate.
- Timer per la saldatura da un solo lato di lamiere sovrapposte.**
- Induttanza elettronica a regolazione continua:** permette, a parità di corrente, di variare la penetrazione della saldatura e ridurre al minimo gli spruzzi.
- **Regolazione sinergica della potenza necessaria per la fusione del metallo.**
- **Regolazione del filo in posizione manuale.**
- **Regolazione fine della corrente di saldatura (+/- 20%) impostato dalla sinergia.**
- **Regolazione della corrente di saldatura in posizione manuale.**

Features

- 11 preset programs** allow the operator to weld all types of the most common metals such as:
 - aluminium-Silicium
 - aluminium-Magnesium
 - mild steel
 - galvanized steel
 - stainless steel
 - high tensile steel and self-shielded wire welding without protective gas for steel.**1 manual program all wires and diameters.**
- Three different types of torch with Euro connection:**
 - a) Standard torch suggested for solid steel welding wires, titanium steel wires, stainless steel wires and self-shielded no gas wires.
 - b) Spool gun torch with synergy regulation device on handle, necessary for Silicium (Si)/Magnesium (Mg) - aluminium wires.
 - c) Torch with synergy regulation device on handle, suggested for CuSi-CuAl brazing and welding wire to weld galvanized metal sheets.
- Timer for one side welding on overlapped metal sheets**
- Continuous regulation of electronic inductor:** it allows, maintaining the same welding current, to change welding penetration and to considerably reduce spatters.
- **Synergic regulation of welding current necessary for metal smelting.**
- **Wire regulation in manual setting.**
- **Fine welding current regulation (+/- 20%) set by synergy.**
- **Welding current regulation in manual setting.**

Caractéristiques

- 11 programmes préétablis** permettent la soudure de tous les métaux les plus communs comme:
 - aluminium au silicium
 - aluminium au magnésium
 - acier normal
 - acier galvanisé
 - acier inoxydable
 - acier particulièrement dure et aussi la soudure, avec fil fourré, sans gaz de protection pour l'acier.**1 programme manuelle pour tous les fils et diamètre.**
- Trois types de torche avec l'attelage Euro:**
 - a) Torche standard conseillée pour fils d'acier cuivré, d'acier au titane, d'acier inoxydable et fourré no-gaz.
 - b) Torche spool gun avec le réglage de la sinergie sur la poignée, indispensable pour les fils aluminium au silicium (Si) et au magnésium (Mg).
 - c) Torche avec le réglage de la sinergie sur la poignée étudiée pour le fil pour soudure/brasure CuSi-CuAl pour les tôles galvanisées.
- Timer pour la soudure d'un seul côté de deux tôles superposées.**
- Inductance électronique à réglage continu:** cela permet, avec le même courant, de varier la pénétration de la soudure et de réduire au minimum les éclaboussures.
- **Réglage sinergique de la puissance nécessaire pour la fusion du métal.**
- **Réglage du fil en position manuelle.**
- **Réglage fin du courant de soudure (+/- 20%) établi par la sinergie.**
- **Réglage du courant de soudure en position manuelle.**

D-mig 530 TDK Synergic



MIG
PROFESSIONAL
TRADITIONAL

Caratteristiche

- Dotate di tecnologia sinergica digitale **SIMPLE WELD** (pag. 41)
- **"1+1 READY"** Questo modello è predisposto per avere la torcia e la Spool Gun sempre collegate
- **"BRAZING"** Per la saldatura del filo acciaio, alluminio MG e Si, CuSi3/CuAl (MIG BRAZING) da utilizzare sui nuovi acciai duri HSS, EHS, UHS, ACCIAIO BORO.
- Interruttore ON/OFF per poter spegnere la macchina senza muovere le regolazioni di potenza
- **"Gas/NO Gas"** Inversione polarità per filo No Gas
- Protezione termica
- Dotate di porta torcia

Features

- Equipped with **SIMPLE WELD** digital synergic technology (pag. 41)
- **"1+1 READY"** This model is made to keep torch and Spool Gun always connected
- For mild steel solid wire or mig braze-wire Cu Si3 / Cu Al (MIG BRAZING) to weld HSS, EHS, UHS and BORO STEEL, aluminium Mg / Si.
- **ON/OFF** switch to turn off the machine without changing the power adjustment
- **"Gas/NO Gas"** Polarity inversion for No Gas wire
- Overload protection
- Equipped with torch holder

Caractéristiques

- Dotés de technologie sinergic digital **SIMPLE WELD** (pag. 41)
- **"1+1 READY"** Cette modèle est proposée pour avoir torche et Spool Gun toujours connecté
- Pour souder le fil acier ms ou fil Cu Si3/ Cu Al (MIG BRAZING) à utiliser avec l'ACIER HSS, EHS, UHS et l'ACIER BORO, aluminium Mg / Si.
- Interrupteur ON/OFF pour débrancher le poste à souder sans déplacer les réglages de puissance
- **"Gas/NO Gas"** Inversion de polarité pour fil No Gas
- Protection thermique
- Equipé d'un soutien pour la torche

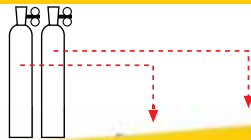

3
PHASE

SIMPLE WELD

SYNERGIC

BRAZING

TURBO

CE

PG

SIMPLE WELD

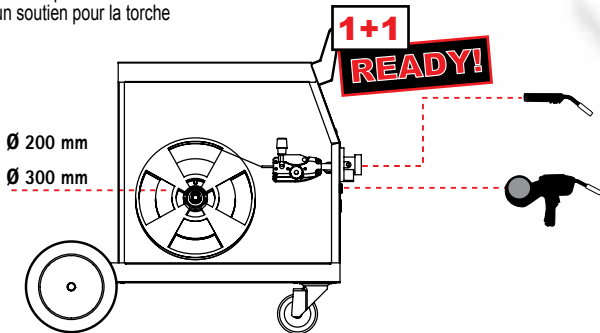

OPTIONAL

BOBINA
SPOOL
BOBINE



Dotazione - Supplied with - Equipés avec

TORCH HOLDER



Ø 0,6 Fe
Ø 0,8 Fe
Ø 0,9 Ss



Caratteristiche tecniche	Technical specifications	Données techniques	D-mig 530 TDK	
Alimentazione	Input voltage	Tension d'alimentation	Volt 50-60 Hz	3 Ph x 230/400
Fusibile di rete	Fuse	Fusible	Amp	16/10
Potenza d'installazione	Installation power	Puissance d'installation	KW 60%	4,5
Tensione a vuoto	Open circuit voltage	Tension à vide	Volt	30
Campo di regolazione	Welding current range	Champ de réglage	Amp (AR-CO ₂)	20 - 220
Servizio	Duty cycle	Facteur de marche	Amp	180 @ 50% 160 @ 60% 125 @ 100%
Posizioni di saldatura	Welding positions	Positions de soudure	N°	10
Dimensioni	Dimensions	Dimensions	mm	505 x 840 x 765
Peso	Weight	Poids	≈kg.	53,5
Filo utilizzabile	Weldable wire	Fil utilisable	Bobina - Spool - Bobine Ø mm. 200 - 300	
Filo acciaio	Steel wire	Fil acier	Ø mm	0,6 - 1,0
Filo inox	Stainless steel wire	Fil inox	Ø mm	0,8 - 1,0
Filo alluminio	Aluminium wire	Fil aluminium	Ø mm	0,8 - 1,0
Filo CuSi 3- CuAl	CuSi 3- CuAl wire	Fil CuSi 3- CuAl	Ø mm	0,8 - 1,0
Filo animato (acciaio)	Self shielded wire (mild steel)	Fil fourré (acier)	Ø mm	0,9



D-mig 532 TDK € Synergic



MIG
PROFESSIONAL
TRADITIONAL

Caratteristiche

- Dotate di tecnologia sinergica digitale **SIMPLE WELD** (pag. 41)
- **"1+1 READY"** Questo modello è predisposto per avere 2 torce sempre collegate.
- **"BRAZING"** Per la saldatura del filo acciaio, alluminio MG e SI, CuSi3/CuAl (MIG BRAZING) da utilizzare sui nuovi acciai duri HSS, EHS, UHS, ACCIAIO BORO.
- Interruttore ON/OFF per poter spegnere la macchina senza muovere le regolazioni di potenza
- Protezione termica
- Dotate di porta torcia

Features

- Equipped with **SIMPLE WELD** digital synergic technology (pag. 41)
- **"1+1 READY"** This model is made to keep 2 torches always connected.
- For mild steel solid wire or mig braze-wire Cu Si3 / Cu Al (MIG BRAZING) to weld HSS, EHS, UHS and BORO STEEL, aluminium Mg / Si.
- ON/OFF switch to turn off the machine without changing the power adjustment
- Overload protection
- Equipped with torch holder

Caractéristiques

- Dotés de technologie sinergic digital **SIMPLE WELD** (pag. 41)
- **"1+1 READY"** Cette modèle est proposée pour avoir 2 torches toujours connecté.
- Pour souder le fil acier ms ou fil Cu Si3 / Cu Al (MIG BRAZING) à utiliser avec l'ACIER HSS, EHS, UHS et l'ACIER BORO, aluminium Mg / Si.
- Interrupteur ON/OFF pour débrancher le poste à souder sans déplacer les réglages de puissance
- Protection thermique
- Equipé d'un soutien pour la torche



3
PHASE

SIMPLE WELD

SYNERGIC

BRAZING

TURBO

CE

PG

SIMPLE WELD

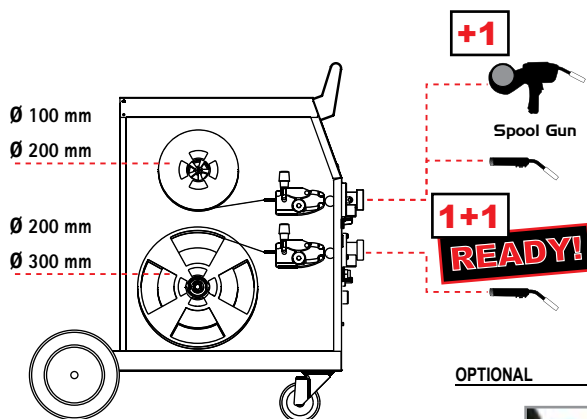

OPTIONAL



Dotazione - Supplied with - Equipés avec



Caratteristiche tecniche	Technical specifications	Données techniques	D-mig 532 TDK E	
Alimentazione	Input voltage	Tension d'alimentation	3 Ph x 230/400	
Fusibile di rete	Fuse	Fusible	16/10	
Potenza d'installazione	Installation power	Puissance d'installation	4,5	
Tensione a vuoto	Open circuit voltage	Tension à vide	30	
Campo di regolazione	Welding current range	Champ de réglage	Amp (AR-CO ₂) 20 - 220	
Servizio	Duty cycle	Facteur de marche	Amp 180 @ 50% 160 @ 60% 125 @ 100%	
Posizioni di saldatura	Welding positions	Positions de soudure	N° 10	
Dimensioni	Dimensions	Dimensions	505 x 840 x 910	
Peso	Weight	Poids	65,0	
Filo utilizzabile	Weldable wire	Fil utilisable	Bobina - Spool - Bobine Ø mm. 100 - 300	
Filo acciaio	Steel wire	Fil acier	Ø mm 0,6 - 1,0	
Filo inox	Stainless steel wire	Fil inox	Ø mm 0,8 - 1,0	
Filo alluminio	Aluminium wire	Fil aluminium	Ø mm 0,8 - 1,0	
Filo CuSi 3- CuAl	CuSi 3- CuAl wire	Fil CuSi 3- CuAl	Ø mm 0,8 - 1,0	



PAC

Plasma Arc Cutting





PROFESSIONAL

I-PAC 1235K (Kompressor)
I-PAC 1235

Pag. 54
Pag. 54



INDUSTRIAL

D-PAC 60 - 90 - 120

Pag. 55

I-PAC Series



PAC
PROFESSIONAL

Impianti per taglio al plasma ad aria compressa

Caratteristiche

- Taglia tutti i metalli, anche particolarmente duri, che conducono elettricità: ferro, inox, alluminio, ottone, rame
- Bassi assorbimenti di corrente
- Arco di taglio dolce e stabile
- Segnalazioni per:
 - macchina alimentata
 - protezione termica
 - mancanza pressione aria (I-PAC 1235)
- Torce dotate di SAFETY SYSTEM
- **Compressore Integrato (I-PAC 1235K)**

Compressed air plasma cutting machines

Features

- It cuts all electricity conductive metals: steel, stainless steel, aluminium, copper, brass, even if very high stright
- Low input energy
- Steady and smooth cutting arc
- Leds indicating:
 - equipment connection to the power
 - thermostatic protection
 - air pressure (I-PAC 1235)
- Torches equipped with SAFETY SYSTEM
- **Built-In Compressor (I-PAC 1235K)**

Equipements pour le coupage au plasma à l'air comprimé

Caractéristiques

- Coupe tous les métaux conducteurs d'électricité: acier, acier inox, aluminium, bronze, laiton, ceux-la particulièrement dures aussi
- Faibles absorptions de courant
- Arc de coupage doux et stable
- Signalation d'installation:
 - suos tension
 - protection thermostatique
 - pression de l'air (I-PAC 1235)
- Torche équipée d'un système de sécurité SAFETY SYSTEM
- **Compresseur intégré (I-PAC 1235K)**

INVERTER

1
PHASE

MICRO
PROCESSOR

KOMPRESSOR



GENERATOR



TURBO



GENERATOR
OUTPUT-VOLTAGE
+/- 30%

Dotazione - Supplied with - Equipés avec

	✓	✓	-	✓
I-PAC 1235	✓	✓	-	✓
I-PAC 1235K	-	✓	✓	-

35AK 4 mt.

40A 4 mt.

Caratteristiche tecniche	Technical specifications	Données techniques		I-PAC 1235	I-PAC 1235K (KOMPRESSOR)
Alimentazione	Input voltage	Tension d'alimentation	Volt 50-60 Hz	1 Ph x 230	1 Ph x 230
Fusibile di rete	Fuse	Fusible	Amp	20	20
Potenza d'installazione	Installation power	Puissance d'installation	KW	4	4
Tensione a vuoto	Open circuit voltage	Tension à vide	Volt	400	400
Corrente di taglio	Cutting current	Courant de coupage	Amp	5 - 35	5 - 35
Servizio	Duty cycle	Facteur de marche	Amp	35 @ 30% 22 @ 60% 15 @ 100%	35 @ 30% 22 @ 60% 15 @ 100%
Spessore max. taglio acciaio	Max. cutting thick steel	Epaiss. coupe max. acier	mm	12	12
Pressione aria	Air pressure	Pression de l'air	Bar	min 3,5 - max 5,0	
Consumo aria	Air consumption	Portée air	l/min	100	
Dimensioni	Dimensions	Dimensions	mm	362 x 170 x 267	325 x 170 x 442
Peso	Weight	Poids	≈kg.	8,8	13,4



D-PAC Series



Impianti per taglio al plasma ad aria compressa

Caratteristiche

- Taglia tutti i metalli, anche particolarmente duri, che conducono elettricità: ferro, inox, alluminio, ottone, rame.
- Arco pilota
- Alta frequenza (D-PAC 90, 120). L'arco pilota s'innesca tramite l'alta frequenza
- Taglio su grigliato con riaccensione dell'arco pilota
- Sistema automatico di raffreddamento della torcia
- Segnalazioni per:
 - macchina alimentata - guasto nella torcia
 - protezione termica - mancanza pressione aria
- Torce dotate di SAFETY SYSTEM

Compressed air plasma cutting machines

Features

- It cuts all electricity conductive metals: steel, stainless steel, aluminum, copper, brass, even if very high strength
- Pilot arc
- High frequency (D-PAC 90, 120). The arc is stroked by high frequency
- Cut on grid, with automatic restart of the pilot arc
- Automatic torch cooling system
- Leds indicating:
 - equipment connection to the power - torch failure
 - thermostatic protection - low air pressure
- Torches equipped with SAFETY SYSTEM

Equipements pour le coupage au plasma à l'air comprimé

Caractéristiques

- Coupe tous les métaux conducteurs d'électricité: acier, acier inox, aluminium, bronze, laiton, ceux-la particulièrement durs aussi
- Arc pilote
- Haute fréquence (D-PAC 90, 120). L'arc s'amorce par haute fréquence
- Decoupage de grille métallique, avec reallumage automatique de l'arc pilote
- Système automatique de refroidissement de la torche
- Signalation d'installation:
 - sous tension - panne de la torche
 - protection thermostatique - pression de l'air
- Torche équipée d'un système de sécurité SAFETY SYSTEM



3
PHASE

MICRO
PROCESSOR



Dotazione - Supplied with - Equipés avec

Model	✓	✓	-	-
D-PAC 60	✓	✓	-	-
D-PAC 90	✓	-	✓	-
D-PAC 120	✓	-	-	✓



Caratteristiche tecniche	Technical specifications	Données techniques		D-PAC 60	D-PAC 90	D-PAC 120
Alimentazione	Input voltage	Tension d'alimentation	Volt 50-60 Hz	3 Ph x 400	3 Ph x 400	3 Ph x 400
Fusibile di rete	Fuse	Fusible	Amp	20	30	50
Potenza d'installazione	Installation power	Puissance d'installation	KW	8	12	20
Tensione a vuoto	Open circuit voltage	Tension à vide	Volt	245	265	267
Corrente di taglio	Cutting current	Courant de coupage	Amp	30 - 50	40 - 80	45 - 120
Servizio	Duty cycle	Facteur de marche	Amp	50 @ 35% 30 @ 100%	75 @ 30% 40 @ 100%	115 @ 30% 45 @ 100%
Spess. max. taglio	Max. cutt. thick. steel	Epaiss. coupe max. acier	mm	12	20	30
Posizioni di regolazione	Adjusting positions	Positions de réglage	N°	2	2	2
Pressione aria	Air pressure	Pression de l'air	Bar	5 - 6	5 - 6	5 - 6
Consumo aria	Air consumption	Porté air	l/min	115	155	215
Dimensioni	Dimensions	Dimensions	mm	534 x 504 x 768	630 x 615 x 855	630 x 615 x 855
Peso	Weight	Poids	≈kg.	51,0	77,0	89,0



SPOT

Resistance Welding
SPOT Welding
STUD Welding





PROFESSIONAL

SW 22
SW 100
SW 15 Alu

Pag. 58
Pag. 59
Pag. 62



Caratteristiche

- MICROPROCESSORE: per la gestione dei parametri di saldatura
- Regolazione potenza e tempo di saldatura
- Selettore punto singolo, pulsato e continuo
- Tabella parametri saldatura
- Indicatore protezione termica
- Pistola con attacco rapido

Features

- MICROPROCESSOR: optimizes the welding parameters
- Power-time setting
- Single, pulsed or continuous spot selector
- Chart Showing welding parameters
- Thermal protective indicator
- Gun with quick connection

Caractéristiques

- MICROPROCESSEUR: optimise tous paramètres de soudure
- Réglage de puissance-temps
- Graphique montrant les paramètres de soudage
- Selecteur point single, point pulsatoire et continu
- Indicateur protection thermique
- Pistolet avec raccord rapide

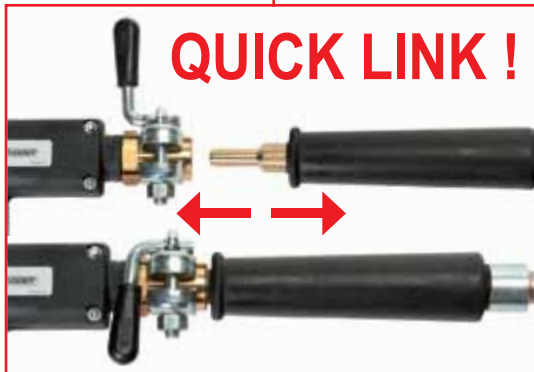

OPTIONAL



Dotazione - Supplied with - Equipés avec

KIT STUDDER



Caratteristiche tecniche	Technical specifications	Données techniques		SW 22 Basic
Alimentazione	Input voltage	Tension d'alimentation	Volt 50-60 Hz	1 Ph x 230
Fusibile ritardato	Delayed fuse	Fusible retardé	Amp	16
Potenza d'installazione	Installation power	Puissance d'installation	KW	4
Tensione a vuoto	Open circuit voltage	Tension à vide	Volt	7,4
Servizio	Duty cycle	Facteur de marche	%	3,5
Dimensioni	Dimensions	Dimensions	mm	320 x 181 x 265
Peso	Weight	Poids	≈kg.	20,0
STUDDER	STUDDER	STUDDER		
Campo di regolazione	Welding current range	Champ de réglage	Amp	400 - 2200
Lunghezza cavi	Cable length	Longueur de câbles	mm	2000 + 3000

SW100



SPOT
PROFESSIONAL

TRADITIONAL

1
PHASE

MICRO
PROCESSOR

SYNERGIC

PULSE
GALVANISED STEEL

SureSpot
Automatic
Compensation

CE

PG

8000A

MICROPROCESSOR
INSIDE

SYNERGIC

PULSE
GALVANISED STEEL

SureSpot
Automatic
Compensation



Dotazione - Supplied with - Equipés avec



SW100 Synergic Digital Control

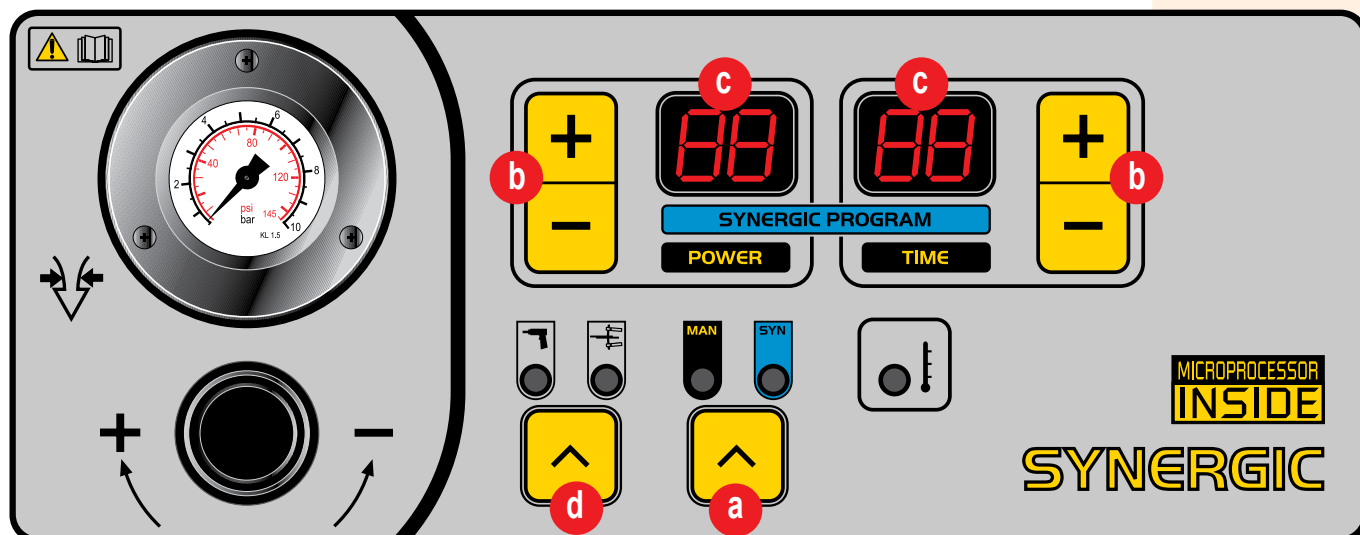

Caratteristiche
MICROPROCESSORE
per la gestione dei parametri di saldatura.

Features
MICROPROCESSOR
optimizes the welding parameters

Caractéristiques
MICROPROCESSEUR
optimise tous paramètres de soudure.



- a) **REGOLAZIONE SINERGICA**
Regola automaticamente i parametri di saldatura in base all'utensile selezionato ed allo spessore da saldare.
- b) Regolazione personalizzabile del tempo e della corrente di lavoro.
- c) Strumento digitale per la regolazione fine
- d) Utilizzo contemporaneo di una pinza puntatrice ed uno studder allo scopo eliminare i tempi di cambio utensile.

- a) **SYNERGETIC ADJUSTMENT**
Automatically sets the welding parameters according to the selected tool and the workpiece thickness.
- b) Adjustable time and spot welding current.
- c) Two-digit instrument for adjustable welding current setting.
- d) Possibility of using at the same time a spot gun and a studder gun in order to avoid any waste of time in tools fitting up.

- a) **REGLAGE SYNERGIE**
Règle automatiquement les paramètres de soudage selon l'outil sélectionné et l'épaisseur de la pièce à souder.
- b) Réglage ajustable du temps et du courant de pointage.
- c) Instrumentation digitale pour le réglage fin.
- d) Utilisation simultanée d'une pince de soudage et de un studder de manière à éliminer toutes pertes de temps pour le changement de l'outil.



Puntatura a punto singolo e punto singolo pulsato per lamiere ad alto limite di snervamento e lamiere zincate.

Continuous single spot and pulsed single spot for sheet metals high yield strength and galvanized steel.

Pointage point single continu et pointage single pulsatoire pour tôles à haute limite de déformation et acier galvanisé.

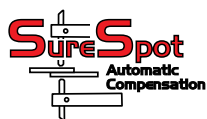

La Compensazione automatica assicura l'uniformità di tutti i punti di saldatura.

Automatic compensation grants all welding spots evenness.

Pointage à temps préréglé compensé.



Caratteristiche tecniche	Technical specifications	Données techniques		SW 100
Alimentazione	Input voltage	Tension d'alimentation	Volt 50-60 Hz	1 Ph x 400
Fusibile ritardato	Delayed fuse	Fusible retardé	Amp (aM)	32
Potenza d'installazione	Installation power	Puissance d'installation	KW (50%)	12
Tensione a vuoto	Open circuit voltage	Tension à vide	Volt	0,8 - 10,1
Campo di regolazione	Welding current range	Champ de réglage	Amp	200 - 8000
Dimensioni	Dimensions	Dimensions	mm	650 x 730 x 1100
Peso	Weight	Poids	=kg.	82,0
PUNTATRICE	SPOT	PINCE À SOUDER		
Capacità di saldatura	Welding capacity	Capacité de soudage	mm	3,0 + 3,0
Punti/h (0,8+0,8 mm)	Spots/h. (0,8+0,8 mm)	Points/h. (0,8+0,8 mm)	N°	600
Punti/h (3,0+3,0 mm)	Spots/h. (3,0+3,0 mm)	Points/h. (3,0+3,0 mm)	N°	75



PNK 25 Air Cooled Gun

Kit Bracci - Kit arms - Kit de bras 010941

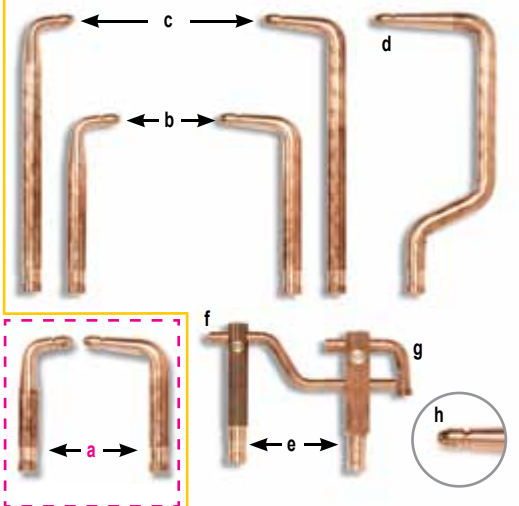

(a) standard	mm. 120	011011	(2 pcs)
(b)	mm. 200	011018	(2 pcs)
(c)	mm. 300	011019	(2 pcs)
(d)	mm. 300	011016	(1 pc)
(e)		010977	(2 pcs)
(f)		010424	(1 pc)
(g)		010423	(1 pc)
(h)		011015	(6 pcs)

PNK 25 Water Cooled Gun



Kit trasformazione Aria/H₂O
Modification Kit Air/H₂O
Kit modification Air/H₂O
010063

(a)	mm. 200	011020	(1 pc)
(b)	mm. 300	011021	(1 pc)



WU 1500
Gruppo di raffreddamento
Water cooling unit
Unité de refroidissement
010651

STUD SW 100



KST4 Kit Studder
(Dotazione - Supplied with - Equipés avec)
010199

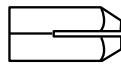

010773 (1 pc)



010772 (20 pcs)



010896 (1 pc)

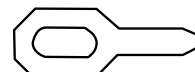

010990 (10 pcs)



010991 (10 pcs)

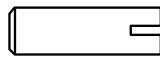

010765 \varnothing 8x16 (1 pc)



010753 \varnothing 8x16x1,5 (100 pcs)

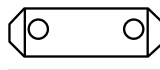

010767 M5-M6 (1 pc)



010759 \varnothing 5x25 (100 pcs)



010760 \varnothing 5x18 (100 pcs)

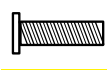

010757 M5x18 (100 pcs)

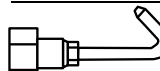

010771 \varnothing 8x16 (1 pc)

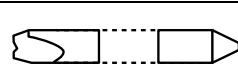

010924 (1 pc)

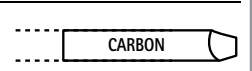

010769 (5 pcs)



010750 Kg. 1 (1 pc)



KPSL 1 Leva
Multihook lever - Levier 010312

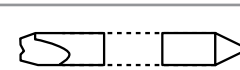

010924 (1 pc)



010958 (10 pcs)

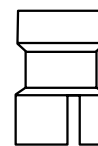

010923 (1 pc)



KPSH1 Kit Traversa
Lifter Crossbar - Traverse tir 010200

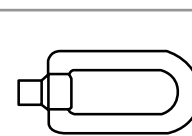

010986 M4 (5 pcs)

010987 M5 (5 pcs)

010988 M6 (5 pcs)

Stud Welding SW 15 ALU



SPOT
PROFESSIONAL

INVERTER

Generatore per saldatura a scarica capacitiva

Caratteristiche

- Progettato ad alto risparmio energetico
- Saldatura a scarica di condensatori
- Cambio tensione alimentazione 115-230 automatico
- Salda perni di diametro da 3 a 8 mm
- Adatto per carrozzieri, installatori, manutentori e settore termotecnica.
- Si può utilizzare su acciaio, acciaio inox, acciaio galvanizzato, ottone, alluminio.
- Non provoca alcuna alterazione della superficie opposta anche se verniciata, plastificata o zincata.

*Protezione motogeneratore +/- 15%

Power source for capacitor discharge welding

Features

- With built in "energy saving" technology
- Capacitor discharge
- Automatic input voltage reverse 115-230
- It studs bolts of from 3 to 8 mm diameter
- Suggested for car repair body shop, heating systems, installation, maintenance works
- It can stud on steel, stainless steel, galvanized steel, brass, aluminium
- No alteration to the opposing welding surface even if painted or plastic-coated or galvanized.

*Protection motogeneratore +/- 15%

Générateur pour le soudage par décharge de condensateurs

Caractéristiques

- Technologie a basse consommation électrique
- Soudage par décharge de condensateurs
- Selection tension d'alimentation 115-230 automatique
- Pour le soudage de prisonniers d'un diamètre de 3 a 8 mm
- Pour les applications dans le secteur de la carrosserie, installation, entretien, thermotéchnique
- Pour le soudage de acier, acier inox, acier galvanisé, laiton, aluminium
- Ne comporte aucune alteration de la surface opposée, même dans le cas de surfaces peintes, plastifiées ou galvanisées

*Protections motogenerateur +/- 15%



1
PHASE

MICRO
PROCESSOR



OPTIONAL

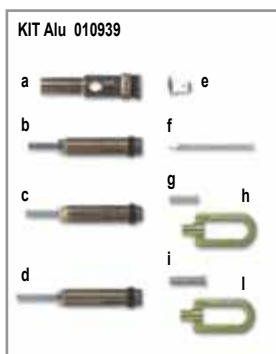

- | | | |
|-------------------|--------|-----------|
| (a) Faston | 010970 | (1 pc) |
| (b) ø 3,0 | 010965 | (1 pc) |
| (c) ø 4,0 | 010966 | (1 pc) |
| (d) ø 5,0 | 010967 | (1 pc) |
| (e) 6,3x0,8 Al/Mg | 010979 | (100 pcs) |
| (f) 3x50 Al/Si | 010978 | (100 pcs) |
| (g) M4x16 Al/Si | 010972 | (100 pcs) |
| (h) M4 | 010986 | (5 pcs) |
| (i) M5x2 Al/Si | 010974 | (100 pcs) |
| (l) M5 | 010987 | (5 pcs) |

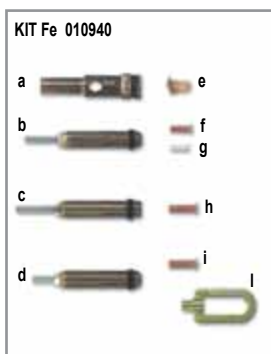

- | | | |
|----------------|--------|-----------|
| (a) Faston | 010970 | (1 pc) |
| (b) ø 4,0 | 010966 | (1 pc) |
| (c) ø 5,0 | 010967 | (1 pc) |
| (d) ø 6,0 | 010968 | (1 pc) |
| (e) 6,3x0,8 Fe | 010983 | (100 pcs) |
| (f) M4x12 Fe | 010980 | (100 pcs) |
| (g) M4x12 Inox | 010984 | (100 pcs) |
| (h) M5x16 Fe | 010989 | (100 pcs) |
| (i) M6x20 Fe | 010975 | (100 pcs) |
| (l) M6 | 010988 | (5 pcs) |



010889



010200

ø 8,0



010969

Caratteristiche tecniche	Technical specifications	Données techniques		SW 15 ALU
Alimentazione	Input voltage	Tension d'alimentation	Volt 50-60 Hz	1 Ph x 115/230
Potenza assorbita	Max Input power	Puissance absorbée	KW	0,4
Ampere assorbiti	Max Input Amps	Ampere absorbée	Amp	8A (115V) - 4A (230V)
Capacità	Capacity	Capacité	µF	66000
Energia di puntatura	Spot energy	Energie de pointage	J	50 ÷ 1500
Numero perni	Spottable stud	Gaujons pour	studs/min	20 studs/min (Ø 4 mm.) 10 studs/min (Ø 8 mm.)
Diametro perni	Spottable stud diameter	Diametre gaujons	mm	3 - 8
Grado di protezione	Protection degree	Degree de protection	IP	21
Dimensioni	Dimensions	Dimensions	mm	380 x 190 x 400
Peso	Weight	Poids	≈kg.	13,5

Dotazione - Supplied with - Equipés avec



BC



Carica Batterie
Battery Chargers
Chargeurs de Batteries





Una vasta gamma di carica batterie per la ricarica delle batterie dei veicoli a motore e delle batterie per trazione (deep cycle).
La scelta ideale per ogni batteria moderna.



A wide range of battery charger for charging batteries of motor vehicles and traction batteries (deep cycle).
The ideal choice for modern batteries.



Une vaste gamme de chargeur de batteries pour la recharge des batteries de véhicules à moteur et batteries de traction (décharge profonde).
Le choix idéal pour les batteries modernes.

WET

Sigillate con all'interno un liquido elettrolitico: a bassa manutenzione oppure senza manutenzione (MF).

Sealed, with liquid electrolyte inside.
Low maintenance or maintenance free (MF).

Scellées avec à l'intérieur un liquide électrolytique: à faible maintenance ou bien sans maintenance (MF).

Realizzate con:

Piombo-antimonio	PbSn
Piombo-calcio	PbCa
Piombo-calcio-argento	PbCaAg

Made with:

Lead-Antimony	PbSn
Lead-Calcium	PbCa
Lead-Calcium-Silver	PbCaAg

Fabriqué avec:

Plomb-Antimoine	PbSn
Plomb- Calcium	PbCa
Plomb-Calcium-Argent	PbCaAg

AGM

Sigillate (VRLA) con elettrolita immobilizzato in un materiale assorbente.

(VRLA) sealed batteries; electrolyte is held on the glass mat separator.

Scellées (VRLA) avec électrolyte immobilisé dans un matériau absorbant.

Realizzate con:

Piombo-calcio	PbCa
----------------------	-------------

Made with:

Lead-Calcium	PbCa
---------------------	-------------

Fabriqué avec:

Plomb- Calcium	PbCa
-----------------------	-------------

GEL

Sigillate (VRLA) con elettrolita immobilizzato in forma di GEL.

(VRLA) sealed battery with a GEL-like, immobile electrolyte.

Scellées (VRLA) avec électrolyte immobilisé sous forme de GEL.

Realizzate con:

Piombo-calcio	PbCa
----------------------	-------------

Made with:

Lead-Calcium: PbCa

Fabriqué avec:

Plomb- Calcium	PbCa
-----------------------	-------------



Electronic Charge / Maintenance

- Prodotti studiati per ricaricare e mantenere pronte all'uso le batterie di auto, moto e mezzi a motore inutilizzati per lunghi periodi.
- Products designed to recharge and keep ready to use the batteries of cars, motorcycles and motor vehicles unused for long periods.
- Produits conçus pour recharger et tenir prêt à l'emploi les batteries de voitures, motos et de véhicules à moteur, inutilisées pendant de longues périodes.



Electronic Charge / Start & Stop

- La soluzione semplice ed economica per la ricarica delle batterie tradizionali ed evolute.
- The simple and affordable solution for charging conventional and advanced batteries.
- La solution simple et abordable pour charger les batteries conventionnelles et avancées.











Electronic Charge / Full Power

- Carica batterie professionali: ricaricano velocemente le batterie e le mantengono al 100% della loro potenza.
- Professional battery charger: recharge batteries quickly and retain 100% of their power.
- Chargeur de batterie professionnel: recharger les batteries plus rapidement et conservez 100% de leur puissance.



Traditional Pro Charge

- Carica batterie tradizionali robusti ed economici, per la ricarica delle batterie WET. Ideali per i mezzi commerciali ed industriali.
- The conventional chargers for charging WET batteries. Ideal for commercial and industrial vehicles.
- Les chargeurs conventionnels pour charger les batteries WET. Idéal pour les véhicules commerciaux et industriels.

		AUTOMOTIVE				TRACTION		
		WET	AGM	AGM** power	GEL	Start Stop	WET AGM-GEL	BOOSTER START ASSIST
	INVERTER MAINTENANCE SM Series pag. 66 SM EVO Series pag. 68	★ ★ ★	★ ★ ★	★ ★ ★	★ ★	★ ★ ★		
	ELECTRONIC FULL POWER FL Series pag. 70	★ ★ ★	★ ★	★ ★ ★	★	★ ★		
	ELECTRONIC FULL POWER DC Traction Series pag. 72						★ ★ ★	
	ELECTRONIC FULL POWER SC Digital Series pag. 74	★ ★ ★	★ ★	★ ★ ★	★	★ ★		BOOSTER START ASSIST SAFE CHARGE BOOST
	ELECTRONIC FULL POWER SC 3000 Series pag. 76	★ ★ ★	★ ★ ★	★ ★ ★	★ ★ ★	★ ★ ★	★ ★ ★	BOOSTER START ASSIST SAFE CHARGE BOOST
	ELECTRONIC STAR & STOP MATIC Series pag. 78	★ ★	★	★ ★	★	★		
	TRADITIONAL PRO CHARGE MACH Series pag. 79	★*	★*	★*		★*		
	TRADITIONAL PRO CHARGE CLASS Series pag. 80	★*	★*	★*		★*		
	TRADITIONAL PRO CHARGE CLASS Booster Series pag. 82	★*	★*	★*		★*		BOOSTER START ASSIST

* Arresto manuale della carica - Manual charge breaker - Arrêt manuel de la charge

** AGM power: Optima®, Maxxima® (round battery)

SM Series

Carica batterie automatici, con programma per la carica di mantenimento (carica ad impulsi).

Adatti alla ricarica di batterie al Piombo:
WET con e senza manutenzione, AGM, GEL, Ca/Ca.

Carica a più fasi

Le batterie vengono caricate applicando dei sofisticati programmi a più fasi.

Alta efficienza

La caratteristica di carica "I-U" (corrente costante - tensione costante) minimizza il tempo di ricarica della batteria.

Funzione mantenimento "Pulse Maintenance"

Possono essere tenuti collegati alla batteria per un tempo prolungato. Mantengono la batteria pronta all'uso attraverso la carica ad impulsi.

Funzione di rigenerazione "Recond Battery"

Rigenera le batterie che hanno subito una scarica profonda (SM1270).

Sicurezza garantita

Progettati per proteggere l'elettronica dei veicoli. Non creano scintille; sono protetti contro le inversioni di polarità ed i corto circuiti.

IP65

Carica batterie leggeri e compatti. Costruiti per un utilizzo all'esterno.

Automatic battery chargers with program for charge conservation (pulse recharge).

Suitable for charging lead batteries:

WET serviceable and maintenance free, AGM, GEL, Ca/Ca.

Multi step charging

The batteries are charged by applying sophisticated multi-step programs.

High efficiency

"I-U" Charging characteristic (constant current - constant voltage) minimises battery charging time.

Maintenance Function "Pulse Maintenance"

Can remain connected to the battery for a long time.

Keeps the battery ready for use through the pulse charge.

Refresh function "Recond Battery"

Regenerate batteries that have undergone heavy discharge cycles (SM1270)

Safety guaranteed

Designed to protect vehicle electronics. Non-sparking.

Reverse polarity protected and short-circuit proof.

IP65

Lightweight and compact battery charger. Built for outdoor use.

Chargeurs de batteries automatiques avec le programme pour la conservation de charge (charge pulsée).

Spécifiques pour charger les batteries au plomb:

WET avec et sans entretien, AGM, GEL, Ca/Ca.

Plusieurs- étapes de charge

Les batteries sont chargées par l'application des programmes sophistiqués de plusieurs étapes.

Haute efficacité

Caractéristique de charge I-U (courant constant - tension constante) minimise le temps de recharge de la batterie.

Fonction de maintenance "Pulse Maintenance"

Ils peuvent être raccordé à la batterie pendant une durée prolongée.

Maintient la batterie prête à l'emploi à travers la charge d'impulsion.

Fonction Refresh "Recond Battery"

Indiqué pour régénérer les batteries qui ont subi des cycles de déchargement poussés (SM1270).

Sécurité garantie

Conçues pour protéger l'électronique des véhicules.

Ne créez pas d'étincelles; sont protégés contre les inversions de polarité et les courts-circuits.

IP65

Chargeur de batterie compact et léger. Conçues pour une utilisation en extérieur.

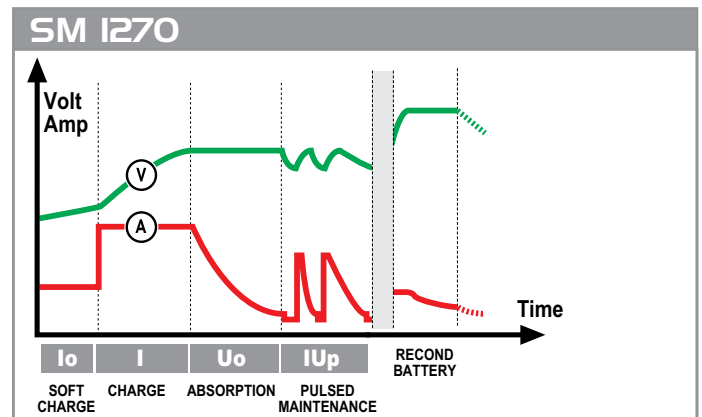
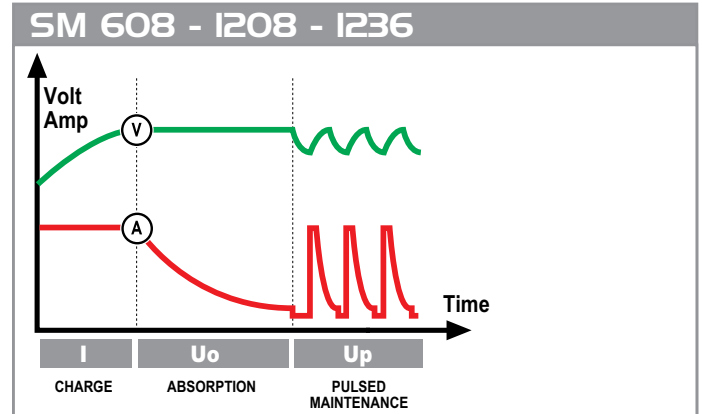

SM 608 / SM 1208 Dotazione - Supplied with - Equipés avec



Caratteristiche tecniche	Technical specifications	Données techniques		SM 608	SM 1208	SM 1236	SM 1270
Alimentazione	Input voltage	Tension d'alimentation	Volt 50-60Hz (AC)	1 Ph x 230	1 Ph x 230	1 Ph x 230	1 Ph x 230
Potenza	Power	Puissance	W	8	14	60	130
Tensione nominale batteria	Nominal battery voltage	Tension nominale de la batterie	Volt	6	12	12	12
Limitazione di tensione	Voltage limitation	Limitation de tension	Volt	7,2	14,4	14,4 - 14,7	14,4 - 14,7
Corrente di carica media	Average charging current	Courant de charge moyen	Amp.	0,8	0,8	0,8 - 3,6	7
Programmi di carica	Charging programs	Programme de charge	N°	1	1	3	4
Tipo di batteria	Battery types	Type de batteries		Pb: WET MF, GEL, AGM, Ca-Ca			
Capacità batteria	Battery capacity	Capacité batteries	Ah min/max	1,2 - 35 (100*)	1,2 - 35 (100*)	1,2 - 75 (120*)	14 - 150 (225*)
Grado di protezione	Protection degree	Degree de protection		IP65	IP65	IP65	IP65
Dimensioni	Dimensions	Dimensions	mm.	157 x 64 x 30	157 x 64 x 30	202 x 90 x 45	202 x 90 x 45
Peso	Weight	Poids	≈kg.	0,36	0,36	0,55	0,65

* nella carica di mantenimento

* on conservation charge

* dans la conservation de charge



SM 608

6 Volt
1,2 - 35 (100) Ah

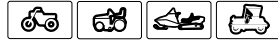

- Programma di ricarica in 3 fasi
- 3 Steps charging program
- Programme de recharge en 3 étapes
- Adattatore per le batterie delle moto
- Adaptor for motorcycle batteries.
- Adaptateur pour les batteries des motos.



SM 1208

12 Volt
1,2 - 35 (100) Ah



- Programma di ricarica in 3 fasi
- 3 Steps charging program
- Programme de recharge en 3 étapes
- Adattatore per le batterie delle moto
- Adaptor for motorcycle batteries.
- Adaptateur pour les batteries des motos.



SM 1236

12 Volt
1,2 - 75 (120) Ah



- Programma di ricarica in 5 fasi**
3 modalità di funzionamento
- Moto: 0,8 Amp 14,4 Volt
 - Auto: 3,6 Amp 14,4 Volt
 - "Basse temperature" e batterie AGM Power: 3,6 Amp 14,7 Volt

- 5 Steps charging program**
3 operation modes
- Bike: 0,8 Amp 14,4 Volt
 - Car: 3,6 Amp 14,4 Volt
 - "Cold weather" and AGM Power batteries: 3,6 Amp 14,7 Volt

- Programme de recharge en 5 étapes**
3 modes de fonctionnement
- Moto: 0,8 Amp 14,4 Volt
 - Auto: 3,6 Amp 14,4 Volt
 - "Température extérieure basses" et batteries AGM Power: 3,6 Amp 14,7 Volt



SM 1270

12 Volt
14 - 150 (225) Ah



- Programma di ricarica in 5 fasi**
4 modalità di funzionamento
- Carica Standard: 7,0 Amp 14,4 Volt
 - "Basse temperature" e batterie AGM Power: 7,0 Amp 14,7 Volt
 - Rigenerazione: 1,5 Amp 16,0 Volt
 - Alimentatore CC (7 Amp 13,6 Volt). Per iniziare la ricarica di batterie troppo scariche / "Back-up"

- 5 Steps charging program**
4 different operation modes
- Normal Charging: 7,0 Amp 14,4 Volt
 - "Cold weather" and AGM Power batteries: 7,0 Amp 14,7 Volt
 - Reconditioning: 1,5 Amp 16,0 Volt
 - DC Power supply (7 Amp 13,6 Volt). Starting the charge of batteries having to low charge / "Back-up"

- Programme de recharge en 5 étapes**
4 modes de fonctionnement différents
- Charge Standard: 7,0 Amp 14,4 Volt
 - "Température extérieure basses" et batteries AGM Power: 7,0 Amp 14,7 Volt
 - Regeneration: 1,5 Amp 16,0 Volt
 - Alimentateur CC (7 Amp 13,6 Volt). Commencer par recharger les batteries très déchargées/ "Back-up"



SM EVO Series

Carica batterie automatici, con programma per la carica di mantenimento (carica ad impulsi).

Adatti alla ricarica di batterie al Piombo: WET con e senza manutenzione, AGM, GEL, Ca/Ca.

Carica a più fasi

Le batterie vengono caricate applicando dei sofisticati programmi a più fasi include la desolfatazione e l'analisi della batteria

Alta efficienza

La caratteristica di carica "I-U" (corrente costante - tensione costante) minimizza il tempo di ricarica della batteria.

Funzione mantenimento "Floating" (massima potenza) e "Pulse"

Possono essere tenuti collegati alla batteria per un tempo prolungato. Mantengono la batteria pronta all'uso attraverso la carica ad impulsi.

Funzione di rigenerazione "Recond Battery"

Rigenera le batterie che hanno subito una scarica profonda (SM1270EVO).

Sicurezza garantita

Progettati per proteggere l'elettronica dei veicoli. Non creano scintille; sono protetti contro le inversioni di polarità ed i corto circuiti.

IP65

Carica batterie leggeri e compatti. Costruiti per un utilizzo all'esterno.

Automatic battery chargers with program for charge conservation (pulse recharge).

Suitable for charging lead batteries: WET serviceable and maintenance free, AGM, GEL, Ca/Ca.

Multi step charging

The batteries are charged by applying sophisticated multi-step programs. Desulphation and analysis of the battery are included.

High efficiency

"I-U" Charging characteristic (constant current - constant voltage) minimises battery charging time.

Maintenance Function "Floating" (max power) and "Pulse Maintenance"

Can remain connected to the battery for a long time. Keeps the battery ready for use through the pulse charge.

Refresh function "Recond Battery"

Regenerate batteries that have undergone heavy discharge cycles (SM1270EVO)

Safety guaranteed

Designed to protect vehicle electronics. Non-sparking. Reverse polarity protected and short-circuit proof.

IP65

Lightweight and compact battery charger. Built for outdoor use.

Chargeurs de batteries automatiques avec le programme pour la conservation de charge (charge pulsée).

Spécifiques pour charger les batteries au plomb: WET avec et sans entretien, AGM, GEL, Ca/Ca.

Plusieurs- étapes de charge

Les batteries sont chargées par l'application des programmes sophistiqués de plusieurs étapes. Désulfatation et l'analyse de la batterie sont inclus

Haute efficacité

Caractéristique de charge I-U (courant constant - tension constante) minimise le temps de recharge de la batterie.

Fonction de maintenance "Floating" (puissance maximale) "Pulse Maintenance"

Ils peuvent être raccordé à la batterie pendant une durée prolongée. Maintient la batterie prête à l'emploi à travers la charge d'impulsion.

Fonction Refresh "Recond Battery"

Indiqué pour régénérer les batteries qui ont subi des cycles de déchargement poussés (SM1270EVO).

Sécurité garantie

Conçues pour protéger l'électronique des véhicules.

Ne créez pas d'étincelles; sont protégés contre les inversions de polarité et les courts-circuits.

IP65

Chargeur de batterie compact et léger. Conçues pour une utilisation en extérieur.

Tester per batteria, avviamento ed alternatore Battery, starter and alternator tester Testeur de batterie, démarreur et d'alternateur

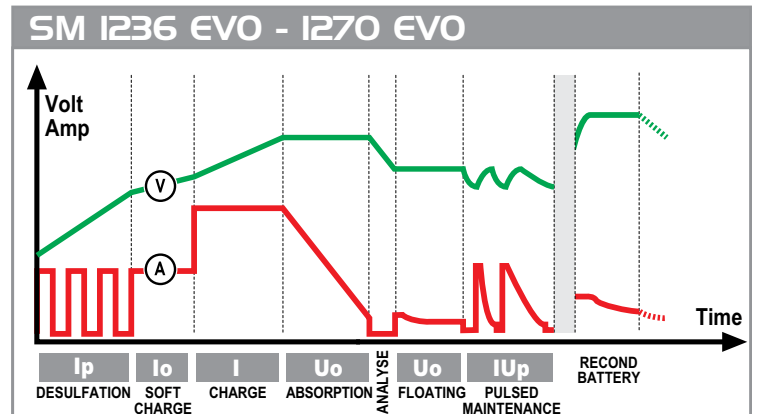

OPTIONAL



Datos técnicos	Technical specifications	Données techniques		SM 1236EVO	SM 1270EVO
Alimentación	Input voltage	Tension d'alimentation	Volt 50-60Hz (AC)	1 Ph x 230	1 Ph x 230
Potencia	Power	Puissance	W	60	120
Tension nominal de batería	Nominal battery voltage	Tension nominale de la batterie	Volt	12	12
Limitación de tensión	Voltage limitation	Limitation de tension	Volt	14,4 - 14,7	14,4 - 14,7
Corriente de carga media	Average charging current	Courant de charge moyen	Amp.	0,8 - 3,6	7
Programa de recarga	Charging programs	Programme de charge	N°	4	4
				Pb: WET MF, GEL, AGM, Ca-Ca	
Tipos de baterías	Battery types	Type de batteries			
Capacidad de batería	Battery capacity	Capacité batteries	Ah min/max	1,2 - 75 (120*)	14 - 150 (225*)
Grado de protección	Protection degree	Degree de protection		IP65	IP65
Dimensiones	Dimensions	Dimensions	mm.	202 x 90 x 45	202 x 90 x 45
Peso	Weight	Poids	≈kg.	0,55	0,65

* nella carica di mantenimento * on conservation charge * dans la conservation de charge

AUTOMOTIVE

WET
AGM
GEL

INVERTER
MAINTENANCE

1
PHASE

MICRO
PROCESSOR

FLOATING
PULSE
MAINTENANCE

BATTERY
TEST



SM I236evo

12 Volt
1,2 - 75 (120) Ah

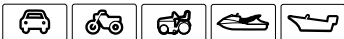

Programma di ricarica in 8 fasi
4 modalità di funzionamento

- Moto: 0,8 Amp 14,4 Volt
- Auto: 3,6 Amp 14,4 Volt
- "Basse temperature" e batterie AGM Power: 3,6 Amp 14,7 Volt
- Alimentatore CC (3,5 Amp 13,6 Volt). Per iniziare la ricarica di batterie troppo scariche / "Back-up"

Tester per batteria, avviamento ed alternatore

8 Steps charging program

4 operation modes

- Bike: 0,8 Amp 14,4 Volt
- Car: 3,6 Amp 14,4 Volt
- "Cold weather" and AGM Power batteries: 3,6 Amp 14,7 Volt
- DC Power supply (3,5 Amp 13,6 Volt). Starting the charge of batteries having to low charge / "Back-up"

Battery, starter and alternator tester

Programme de recharge en 8 étapes

4 modes de fonctionnement

- Moto: 0,8 Amp 14,4 Volt
- Auto: 3,6 Amp 14,4 Volt
- "Température extérieure basses" et batteries AGM Power: 3,6 Amp 14,7 Volt
- Alimentateur CC (3,5 Amp 13,6 Volt). Commencer par recharger les batteries très déchargées/ "Back-up"

Testeur de batterie, démarreur et d'alternateur



SM I270evo

12 Volt
14 - 150 (225) Ah



Programma di ricarica in 8 fasi
4 modalità di funzionamento

- Carica Standard: 7,0 Amp 14,4 Volt
- "Basse temperature" e batterie AGM Power: 7,0 Amp 14,7 Volt
- Rigenerazione: 1,5 Amp 16,0 Volt
- Alimentatore CC (7 Amp 13,6 Volt). Per iniziare la ricarica di batterie troppo scariche / "Back-up"

Tester per batteria, avviamento ed alternatore

8 Steps charging program

4 different operation modes

- Normal Charging: 7,0 Amp 14,4 Volt
- "Cold weather" and AGM Power batteries: 7,0 Amp 14,7 Volt
- Reconditioning: 1,5 Amp 16,0 Volt
- DC Power supply (7 Amp 13,6 Volt). Starting the charge of batteries having to low charge / "Back-up"

Battery, starter and alternator tester

Programme de recharge en 8 étapes

4 modes de fonctionnement différents

- Charge Standard: 7,0 Amp 14,4 Volt
- "Température extérieure basses" et batteries AGM Power: 7,0 Amp 14,7 Volt
- Regeneration: 1,5 Amp 16,0 Volt
- Alimentateur CC (7 Amp 13,6 Volt). Commencer par recharger les batteries très déchargées/ "Back-up"

Testeur de batterie, démarreur et d'alternateur



12 Volt
14 - 150 (225) Ah

Carica batterie automatico con controllo elettronico della corrente di carica e mantenimento della carica "Floating".

- Adatti alla ricarica di batterie al Piombo: WET con e senza manutenzione, AGM, GEL, Ca/Ca.
- **Carica a più fasi** - Le batterie vengono caricate applicando dei sofisticati programmi a più fasi.
- **Alta efficienza** - La caratteristica di carica "I-U" (corrente costante - tensione costante) minimizza il tempo di ricarica della batteria.
- **Floating** - Può essere tenuto collegato alla batteria per un tempo prolungato. Mantiene la batteria pronta all'uso.
- **Sicurezza garantita** - Progettati per proteggere l'elettronica dei veicoli. Non creano scintille; sono protetti contro le inversioni di polarità ed i corto circuiti. La tensione di carica è priva d'interferenze e picchi di tensione. Permette la carica della batteria direttamente nel sistema elettrico del veicolo, senza scollegare la batteria. (DIN 40839 livello I di emissioni interferenze).
- **Test Batteria** - Riconoscimento delle batterie solfatate (FL 1112; FL 2212 esclusi).
- **"Sulfated Battery Recovery"** Programma di Desolfatazione / Equalizzazione Rigenera le batterie che hanno subito una scarica profonda. (FL 1112; FL 2212 esclusi).
- Carica batterie ideali per l'officina.

Fully automatic battery chargers built with electronic charge control and charging conservation "Floating".

- Suitable for charging lead batteries: WET serviceable and maintenance free, AGM, GEL, Ca/Ca.
- **Multi step charging** - The batteries are charged by applying sophisticated multi-step programs.
- **High efficiency** - "I-U" Charging characteristic (constant current-constant voltage) minimises battery charging time.
- **Floating** - Can remain connected to the battery for a long time. Batteries are ready to use at all times.
- **Safety guaranteed** - Designed to protect vehicle electronics. Non-sparking. Reverse polarity protected and short-circuit proof. Charging voltage is free of interference and voltage peaks. Allow battery charging directly on the vehicle electrical system, without disconnecting the battery. (DIN 40839 interference emission level I)
- **Battery Test** - Sulphated battery detection (FL 1112; FL 2212 excluded).
- **"Sulfated Battery Recovery"** Desulphation / Equalization programme Regenerate batteries that have undergone heavy discharge cycles. (FL 1112; FL 2212 excluded).
- Battery charger suitable for the workshop.

Chargeur de batterie entièrement automatique construit avec le contrôle de charge électronique et conservation de charge "Floating".

- Spécifiques pour charger les batteries au plomb: WET avec et sans entretien, AGM, GEL, Ca/Ca.
- **Plusieurs-étapes de charge** - Les batteries sont chargées par l'application des programmes sophistiqués de plusieurs étapes.
- **Haute efficacité** - Caractéristique de charge I-U (courant constant - tension constante) minimise le temps de recharge de la batterie.
- **Floating** - Peut être raccordé à la batterie pendant une durée prolongée. Maintient la batterie prête à l'emploi.
- **Sécurité garantie** - Conçues pour protéger l'électronique des véhicules. Ne crée pas d'étincelles; sont protégées contre les inversions de polarité et les courts-circuits. La tension de charge est libre d'interférences et surtensions. Permettent chargement de la batterie directement sur le système électrique du véhicule, sans débrancher la batterie. (DIN 40839 niveau d'émission des interférences)
- **Test de batterie** - Sulphated battery automatic detection (FL 1112; FL 2212 exclu).
- **"Sulfated Battery Recovery"** Desulphation / Egalization Programme Indiqué pour régénérer les batteries qui ont subi des cycles de déchargement poussés. (FL 1112; FL 2212 exclu).
- Chargeur de batterie adapté à l'atelier.

FUSE



FL 1112 - 1113D
fuse 15A (10 pcs) 010293

FL 2212 - 2213D
fuse 30A (10 pcs) 010295

FL 3713D
fuse 40A (10 pcs) 010278

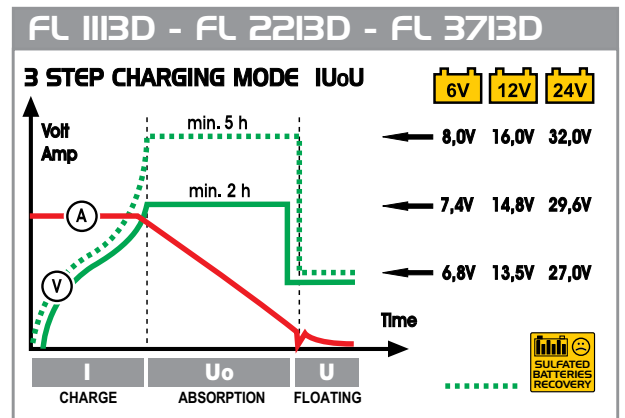
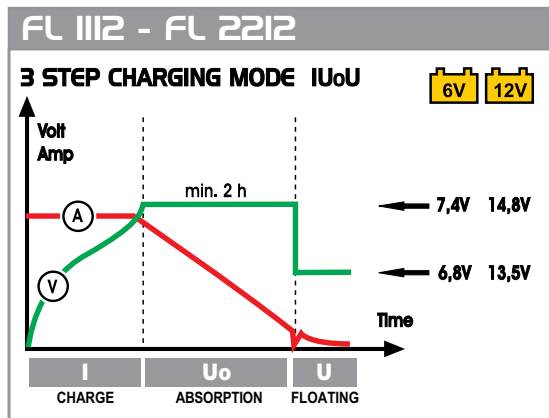

Caratteristiche tecniche	Technical specifications	Données techniques		FL 1112	FL 1113D	FL 2212	FL 2213D	FL 3713D
Alimentazione	Input voltage	Tension d'alimentation	Volt 50-60Hz (AC)	1 Phx230	1 Phx230	1 Phx230	1 Phx230	1 Phx230
Potenza	Power	Puissance	W	120	260	260	530	760
Tensione nominale batteria	Nominal battery voltage	Tension nominale de la batterie	Volt	6 / 12	6 / 12 / 24	6 / 12	6 / 12 / 24	6 / 12 / 24
Limitazione di tensione	Voltage limitation	Limitation de tension	Volt	7,4 - 14,8	7,4 - 14,8 - 29,6	7,4 - 14,8	7,4 - 14,8 - 29,6	7,4 - 14,8 - 29,6
Corrente di carica media	Average charging current	Courant de charge moyen	Amp.	1,5 - 3,5 - 7,0	1,5 - 3,5 - 7,0	3,5 - 7,0 - 15,0	3,5 - 7,0 - 15,0	7,0 - 15,0 - 25,0
Corrente di carica efficace	Effective charging current	Courant de charge effectif	Amp. (MAX)	11	11	22	22	37
Posizioni di carica	Charging positions	Positions de charge	N.	3	3	3	3	3
Tipo di batterie	Battery types	Type de batteries		Pb: WET MF, GEL, AGM, Ca-Ca				
Programmi di carica	Charging programs	Programme de charge	N.	1	2	1	2	2
Capacità batteria	Battery capacity	Capacité batterie	Ah 15h min/max	8 / 130	8 / 130	15 / 260	15 / 260	30 / 450
Dimensioni	Dimensions	Dimensions	mm.	312 x 173 x 127				395 x 252 x 210
Peso	Weight	Poids	=kg.	3,5	5,3	5,3	6,3	12

AUTOMOTIVE
WET
AGM
GEL

ELECTRONIC
FULL POWER



1
PHASE

MICRO
PROCESSOR

FLOATING
MAINTENANCE



FL 1112



6 - 12 Volt
8 - 130 Ah



FL 2212



6 - 12 Volt
15 - 260 Ah



FL 1113D



6 - 12 - 24 Volt
8 - 130 Ah



FL 2213D



6 - 12 - 24 Volt
15 - 260 Ah

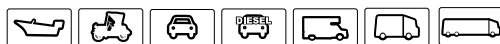

FL 3713D



6 - 12 - 24 Volt
30 - 450 Ah



DC Traction Series

Batterie per trazione / deep cycle

Carica batterie automatico con controllo elettronico della corrente di carica e mantenimento della carica "Floating".

- Adatti alla ricarica di batterie al Piombo: WET con e senza manutenzione, AGM, GEL.

Caratteristiche

- **Carica a più fasi** - Le batterie vengono caricate applicando dei sofisticati programmi a più fasi.
- **Alta efficienza** - La caratteristica di carica "I-U" (corrente costante - tensione costante) minimizza il tempo di ricarica della batteria.
- **Floating** - Può essere tenuto collegato alla batteria per un tempo prolungato. Mantiene la batteria pronta all'uso.
- **Programma di equalizzazione**.
- **Sensore di temperatura**. Compensa automaticamente la tensione di carica in base alla temperatura ambiente.
- **Sicurezza garantita**. Non creano scintille; sono protetti contro le inversioni di polarità ed i corti circuiti.
- Carica batterie ideali per camper, barche, golf-cart, spazzatrici, sollevatori.

Traction batteries / Deep cycle

Fully automatic battery chargers built with electronic charge control and charging conservation "Floating".

- Suitable for charging lead batteries: WET serviceable and maintenance free, AGM, GEL.

Features

- **Multi step charging** - The batteries are charged by applying sophisticated multi-step programs.
- **High efficiency** - "I-U" Charging characteristic (Constant current - constant voltage) minimises battery charging time.
- **Floating** - Can remain connected to the battery for a long time. Batteries are ready to use at all times.
- **Temperature sensor** - Automatically compensates any charging voltage according to ambient temperature.
- **Equalization programme**.
- **Safety guaranteed** - Non-sparking. Reverse polarity protected and short-circuit proof.
- **Equalization programme**.
- Battery charger suitable for van, boat, trolley, golf-cart, sweeper, lifter.

Batteries de traction / dé charge profonde

Chargeur de batterie entièrement automatique construit avec le contrôle de charge électronique et conservation de charge "Floating".

- Spécifiques pour charger les batteries au plomb: WET avec et sans entretien, AGM, GEL.

Caractéristiques

- **Plusieurs-étapes de charge** - Les batteries sont chargées par l'application des programmes sophistiqués de plusieurs étapes.
- **Haute efficacité** - Caractéristique de charge I-U (courant constant - tension constante) minimise le temps de recharge de la batterie.
- **Floating** - Peut être raccordé à la batterie pendant une durée prolongée. Maintient la batterie prête à l'emploi.
- **Equalization Program**.
- **Capteur de température**. Compense automatiquement la tension de charge en fonction de la température ambiante.
- **Sécurité garantie** - Ne créez pas d'étincelles; sont protégés contre les inversions de polarité et les courts-circuits.
- Chargeur de batterie adapté pour van, bateau, chariot, voiturette de golf, balayeuse, poussoir.



FUSE



DC 2213 Traction
fuse 30A (10 pcs) 010295

DC 3713 Traction
fuse 40A (10 pcs) 010278

DC Traction

4 STEP CHARGING MODE IUoIUoU

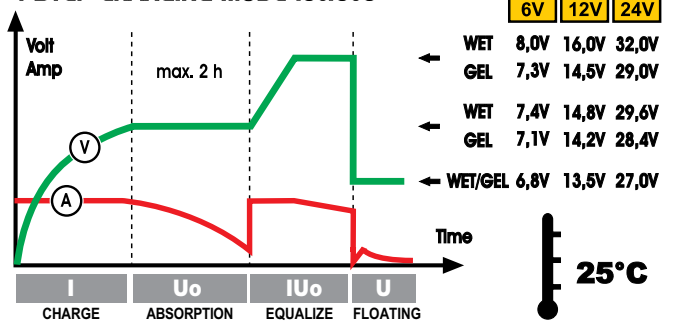

Caratteristiche tecniche	Technical specifications	Données techniques		DC 2213 Traction	DC 3713 Traction
Alimentazione	Input voltage	Tension d'alimentation	Volt 50-60Hz (AC)	1 Ph x 230	1 Ph x 230
Potenza	Power	Puissance	W	530	760
Tensione nominale batteria	Nominal battery voltage	Tension nominale de la batterie	Volt	6 / 12 / 24	6 / 12 / 24
Limitazione di tensione	Voltage limitation	Limitation de tension	Volt	WET 7,4 - 14,8 - 29,6 GEL 7,3 - 14,5 - 29,0	WET 7,4 - 14,8 - 29,6 GEL 7,3 - 14,5 - 29,0
Corrente di carica media	Average charging current	Courant de charge moyen	Amp.	3,5 - 7,0 - 15,0	7,0 - 15,0 - 25,0
Corrente di carica efficace	Effective charging current	Courant de charge effectif	Amp. (MAX)	22	37
Posizioni di carica	Charging positions	Positions de charge	N.	3	3
Tipo di batterie	Battery types	Type de batteries		Pb: WET MF, GEL, AGM	
Programmi di carica	Charging programs	Programme de charge	N.	2	2
Capacità batteria	Battery capacity	Capacité batterie	Ah 15h min/max	15 / 160	30 / 270
Dimensioni	Dimensions	Dimensions	mm.	312 x 173 x 127	395 x 252 x 210
Peso	Weight	Poids	=kg.	6,3	12

TRACTION WET
AGM
GEL

ELECTRONIC
FULL POWER



NEW

1
PHASE

MICRO
PROCESSOR

FLOATING
MAINTENANCE



CE



DC 2213 Traction



6 - 12 - 24 Volt
15 - 160 Ah

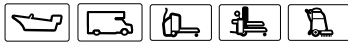

NEW

DC 3713 Traction



6 - 12 - 24 Volt
30 - 270 Ah

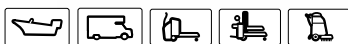

SC Digital Series

Carica batterie ed avviatore rapido professionale, controllato da microprocessore.

- Adatti alla ricarica di batterie al Piombo: WET con e senza manutenzione, AGM, GEL, Ca/Ca

Caratteristiche

- **“Safe Charge & Boost”**: Il sistema protegge l'elettronica montata nei veicoli da eventuali interferenze e sovra-tensioni che potrebbero generarsi durante la carica o durante l'avviamento rapido. (DIN 408399 emissione di interferenze livello I).
- **Carica a più fasi** - Le batterie vengono caricate applicando dei sofisticati programmi a più fasi.
- **Floating** - Può essere tenuto collegato alla batteria per un tempo prolungato. Mantiene la batteria pronta all'uso.
- **Regolazione fine della corrente**. Ti consente di caricare in maniera ottimale le batterie di tutte le capacità (Ah).
- **Carica con timer**
- **Comando a distanza per l'avviamento**
- **Voltmetro / amperometro digitale**
- **Protezione termostatica a riarmo automatico**
- **Protezione contro le inversioni di polarità e corto circuiti**
- **Pinze Heavy Duty**

Professional microprocessor-controlled battery charger and starter.

- Suitable for charging lead batteries: WET serviceable and maintenance free, AGM, GEL, Ca/Ca

Features

- **“Safe Charge & Boost”**: The system protects the electronic components on the vehicle against interference and overvoltage that may be created at the charging or quick starting procedures. (DIN 408399 interference emission level I).
- **Multi step charging** - The batteries are charged by applying sophisticated multi-step programs.
- **Floating** - Can remain connected to the battery for a long time. Batteries are ready to use at all times.
- **Continuously adjustable charge current**. Lets you charge optimally batteries of all capacities (Ah).
- **Charging with timer**
- **Boosting remote control**
- **Digital Voltmeter / Ammeter**
- **Overload protection with automatic reset**
- **Inversions of polarity and short circuits protection**
- **Heavy duty clamps**

Chargeur de batteries et démarreur rapide professionnel, contrôlé par un microprocesseur.

- Spécifiques pour charger les batteries au plomb: WET avec et sans entretien, AGM, GEL, Ca/Ca

Caractéristiques

- **“Safe Charge & Boost”**: Le système protège l'électronique montée dans les véhicules contre les éventuelles interférences et surtensions qui pourraient se générer durant la charge ou durant le démarrage rapide. (DIN 408399 niveau I d'émission des interférences).
- **Plusieurs-étapes de charge** - Les batteries sont chargées par l'application des programmes sophistiqués de plusieurs étapes.
- **Floating** - Peut être raccordé à la batterie pendant une durée prolongée. Maintient la batterie prête à l'emploi.
- **Réglage fin du courant**. Vous permet de charger de manière optimale les batteries de toutes les capacités (Ah).
- **Charge avec temporisateur**
- **Commande à distance pour le démarrage**
- **Protection à réarmement automatique contre les surcharges**
- **Protection contre les inversions de polarité et court circuits**
- **Pincers robustes**



FUSE 

SC Series
fuse 100A (12 pcs) 010292

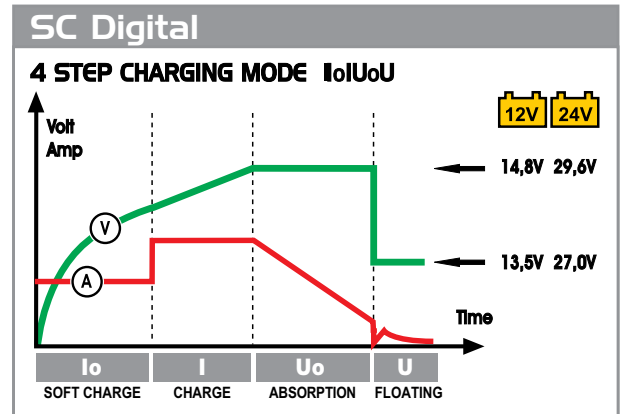

Caratteristiche tecniche	Technical specifications	Données techniques		SC 30/400	SC 60/700	SC 80/900
Alimentazione	Input voltage	Tension d'alimentation	Volt 50-60Hz (AC)	1 Ph x 230	1 Ph x 230	1 Ph x 230
Potenza	Power	Puissance	KW	0,7 / 7,8	1,3 / 13,5	1,7 / 16,8
Tensione nominale batteria	Nominal battery voltage	Tension nominale de la batterie	Volt	12 / 24	12 / 24	12 / 24
Limitazione di tensione	Voltage limitation	Limitation de tension	Volt	14,8 (12V) - 29,6 (24V)	14,8 (12V) - 29,6 (24V)	14,8 (12V) - 29,6 (24V)
Corrente di carica media	Average charging current	Courant de charge moyen	Amp.	20	40	50
Corrente di carica efficace	Effective charging current	Courant de charge effectif	Amp.	30	60	80
Posizioni di carica	Charging positions	Positions de charge	N°	STEPLESS	STEPLESS	STEPLESS
Corrente di avviamento	Boosting current	Courant de démarrage	Amp. 0 Volt (CC)	400	700	900
Corrente di avviamento	Boosting current	Courant de démarrage	Amp. 1 Volt/EL	230	400	500
Tipo di batteria	Battery types	Type de batteries		Pb: WET MF, AGM, Ca-Ca.		
Capacità batteria	Battery capacity	Capacité batteries	Ah min/max	5 / 400	5 / 800	5 / 1000
Dimensioni	Dimensions	Dimensions	mm.	390 x 280 x 903		
Peso	Weight	Poids	=kg.	20,6	24,0	26,7



1
PHASE

MICRO
PROCESSOR

FLOATING
MAINTENANCE



SC 80/900  12 - 24 Volt
5 - 1000 Ah



SC 60/700  12 - 24 Volt
5 - 800 Ah



SC 30/400  12 - 24 Volt
5 - 400 Ah

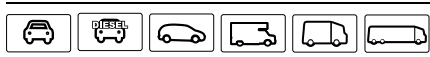

SC 3000 Series

Carica batteria ed avviatore rapido professionale, controllato da microprocessore.

- Adatti alla ricarica di batterie al Piombo: WET con e senza manutenzione, AGM, GEL, Ca/Ca e delle batterie da trazione DEEP CYCLE.

Professional microprocessor-controlled battery charger and starter.

- Suitable for charging lead batteries: WET serviceable and maintenance free, AGM, GEL, Ca/Ca and traction batteries DEEP CYCLE.

Chargeur de batteries et démarreur rapide professionnel, contrôlé par un microprocesseur.

- Spécifiques pour charger les batteries au plomb: WET avec et sans entretien, AGM, GEL, Ca/Ca et des batteries de traction DEEP CYCLE.



SC 3300B



**6 - 12 - 24 Volt
5 - 800 Ah**



SC 3230B



**6 - 12 - 24 Volt
5 - 600 Ah**

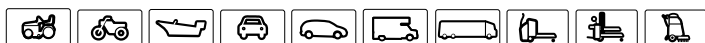

FUSE 

fuse 80A (10 pcs) 010297

OPTIONAL



Caratteristiche tecniche	Technical specifications	Données techniques		SC 3230 B	SC 3300 B
Alimentazione	Input voltage	Tension d'alimentation	Volt 50-60Hz (AC)	1 Ph x 230	1 Ph x 230
Potenza	Power	Puissance	KW	0,8 / 7	1,2 / 10
Tensione nominale batteria	Nominal battery voltage	Tension nominale de la batterie	Volt	6 / 12 / 24	6 / 12 / 24
Limitazione di tensione	Voltage limitation	Limitation de tension	Volt	Regolabile - Adjustable - Réglable	Regolabile - Adjustable - Réglable
Corrente di carica media	Average charging current	Courant de charge moyen	Amp.	30	40
Corrente di carica efficace	Effective charging current	Courant de charge effectif	Amp. (MAX)	45	60
Posizioni di carica	Charging positions	Positions de charge	N°	STEPLESS	STEPLESS
Programmi di carica	Charging programs	Programme de charge	N°	4	4
Corrente di avviamento	Boosting current	Courant de démarrage	Amp. 0 Volt (CC)	250	350
Corrente di avviamento	Boosting current	Courant de démarrage	Amp. 1 Volt/EL	230	300
Tipo di batteria	Battery type	Type de batteries		Pb: WET MF, GEL, AGM, Ca-Ca, Traction/Deep Cycle	
Capacità batteria	Battery capacity	Capacité batterie	Ah min/max	5 / 600	5 / 800
Dimensioni	Dimensions	Dimensions	mm.	450 x 250 x 285	
Peso	Weight	Poids	=kg.	17,5	20,0

AUTOMOTIVE

TRACTION

WET
AGM
GEL**ELECTRONIC**
FULL POWER

Multifunction Charger Booster

1
PHASEMICRO
PROCESSOR

Caratteristiche

- A** • **“Safe Charge & Boost”**
Il sistema protegge l'elettronica montata nei veicoli da eventuali interferenze e sovra-tensioni che potrebbero generarsi durante la carica o durante l'avviamento rapido.
(DIN 40839 emissione di interferenze livello I).
In aggiunta, puoi modificare le soglie di tensione delle fasi di carica per adattarle alle richieste delle batterie speciali.
(es: Optima, MaXXima).
Il carica batterie ti aiuta a verificare la corretta selezione della tensione di batteria; la presenza di corto circuiti ed inversioni di polarità.
- B** • **4 programmi di carica a più fasi**
Le batterie al Piombo WET, AGM, GEL, Ca/Ca e per trazione "Deep cycle", vengono caricate applicando dei sofisticati programmi a più fasi: (IUOU; IUIOU; IU).
- Ricarica
- Equalizzazione
- Mantenimento ("Floating")
- Desolfatazione
- **Regolazione fine della corrente**
Ti consente di caricare in maniera ottimale le batterie di tutte le capacità (Ah).
- C** • **Funzione "Booster"**
per l'avviamento rapido
- D** • **Sensore di temperatura**
Compensa automaticamente la tensione di carica in base alla temperatura ambiente.
- **Test batteria**
Il carica batterie verifica se la batteria è solfatata e se può mantenere la ricarica.
- **"Memory"**
La funzione ti facilita l'uso: è sufficiente collegare il carica batterie alla batteria ed alla rete elettrica per iniziare subito la carica in base all'ultimo programma che hai impostato.
- **"Back-up"**
La funzione alimenta l'elettronica montata nei veicoli mentre viene sostituita la batteria e non fa perdere i dati memorizzati (regolazioni della radio, dei sedili, eccetera).

Features

- **“Safe Charge & Boost”**
The system protects the electronic components on the vehicle against interference and overvoltage that may be created at the charging or quick starting procedures.
(DIN 40839 interference emission level I)
Furthermore, the voltage thresholds for the charging steps may be modified in order to adapt them to special batteries.
(eg: Optima, MaXXima).
This battery charger helps you to check that the battery voltage selected is the right one, and if a short circuit or a reverse polarity occurs.
- **4 Multi step charging programs**
The lead batteries WET, AGM, GEL, Ca/Ca and traction "Deep cycle", are charged by applying sophisticated multi-step programs: (IUOU; IUIOU; IU).
- Charging
- Equalization
- Maintenance ("Floating")
- Desulphation
- **Continuously adjustable charge current**
Lets you charge optimally batteries of all capacities (Ah).
- **"Booster" function**
for start assist
- **Temperature sensor**
Automatically compensates any charging voltage according to ambient temperature.
- **Battery check**
The battery charger checks if the battery is sulphated and if it can store the charge.
- **"Memory"**
The function makes this product easy to use: Just connect the battery charger to a battery and to the mains and charging begins following the last programme set.
- **"Back-up"**
The function powers the vehicle electronics while the battery is being replaced and so saved data are not lost (radio and seat settings, for instance).

Caractéristiques

- **“Safe Charge & Boost”**
Le système protège l'électronique montée dans les véhicules contre les éventuelles interférences et surtensions qui pourraient se générer durant la charge ou durant le démarrage rapide.
(DIN 40839 niveau d'émission des interférences)
De plus, vous pouvez modifier les seuils de tension des phases de charge pour les adapter aux exigences des batteries spéciales.
(par exemple: Optima, MaXXima).
Le chargeur de batteries vous aide à vérifier la bonne sélection de la tension de la batterie ; la présence de courts-circuits et les inversions de polarité.
- **4 programmes de charge avec plusieurs- étapes**
Les batteries au plomb: WET, AGM, GEL, Ca/Ca et de traction "Deep cycle", sont chargées par l'application des programmes sophistiqués de plusieurs étapes: (IUOU; IUIOU; IU).
- Charge
- Egalisation
- Maintenance ("Floating")
- Désulfatation
- **Réglage fin du courant**
Vous permet de charger de manière optimale les batteries de toutes les capacités (Ah).
- **Fonction "Booster"**
pour le démarrage rapide
- **Capteur de température**
Compense automatiquement la tension de charge en fonction de la température ambiante.
- **Contrôle de la batterie**
Le chargeur de batteries vérifie si la batterie est sulfatée et si elle peut maintenir la charge.
- **"Memory"**
La fonction vous facilite l'utilisation: il suffit de raccorder le chargeur de batteries à la batterie et au réseau électrique pour commencer immédiatement la charge en fonction du dernier programme réglé.
- **"Back-up"**
La fonction alimente l'électronique montée dans les véhicules pendant le remplacement de la batterie et ne fait pas disparaître les données mémorisées (réglages de la radio, des sièges, etc.).

MATIC Series

AUTOMOTIVE WET AGM GEL

ELECTRONIC
STAR & STOP

Carica batterie automatico con controllo elettronico della corrente di carica, fine carica e ripristino automatico.

- Adatti alla ricarica di batterie al Piombo: WET con e senza manutenzione, AGM, GEL, Ca/Ca
- Led di segnalazione: alimentazione, carica in corso, batteria carica, inversione di polarità.
- Protezione termostatica a riarmo automatico.
- Protezione contro le inversioni di polarità e corto circuiti.

Fully automatic battery chargers built with electronic charge control, automatic charge breaker and automatic reset.

- Suitable for charging lead batteries: WET serviceable and maintenance free, AGM, GEL, Ca/Ca.
- Led indicators: input voltage, battery in charging progress, battery charged, inversion of polarity.
- Overload protection with automatic reset.
- Inversions of polarity and short circuits protection.

Chargeur de batterie entièrement automatique construit avec le contrôle de charge électronique, fin de charge et réarmement automatiques.

- Spécifiques pour charger les batteries au plomb: WET avec et sans entretien, AGM, GEL, Ca/Ca.
- Led de signalisation: tension d'alimentation, charge de la batterie en cours, batterie chargée, inversion de polarité.
- Protection à réarmement automatique contre les surcharges.
- Protection contre les inversions de polarité et court circuits.

1
PHASE



MATIC I13 12 Volt 3 - 30 Ah



MATIC I16 12 Volt 5 - 90 Ah



MATIC I19 12 Volt 10 - 120 Ah



FUSE

MATIC 113
fuse 3A (10 pcs) 010279

- **Led di segnalazione:**
 - alimentazione
 - inversione di polarità
 - carica in corso
 - batteria carica
- **Led indicators:**
 - input voltage
 - battery in charging progress
 - battery charged
- **Led de signalisation:**
 - tension d'alimentation
 - inversion de polarité
 - charge de la batterie en cours
 - batterie chargée

Caratteristiche tecniche	Technical specifications	Données techniques		MATIC 113	MATIC 116	MATIC 119
Alimentazione	Input voltage	Tension d'alimentation	Volt 50-60Hz (AC)	1 Ph x 230	1 Ph x 230	1 Ph x 230
Potenza	Power	Puissance	W	30	80	115
Tensione nominale batteria	Nominal battery voltage	Tension nominale de la batterie	Volt	12	12	12
Limitazione di tensione	Voltage limitation	Limitation de tension	Volt	14,4	14,4	14,4
Corrente di carica media	Average charging current	Courant de charge moyen	Amp.	1	4	6
Corrente di carica efficace (MAX)	Effective charging current (MAX)	Courant de charge effectif (MAX)	Amp.	1,5	6	9
Tipo di batterie	Battery types	Type de batteries		Pb: WET MF, GEL, AGM, Ca-Ca		
Capacità batteria	Battery capacity	Capacité batterie	Ah 15h min/max	3 / 30	5 / 90	10 / 120
Dimensioni	Dimensions	Dimensions	mm.		225 x 160 x 95	
Peso	Weight	Poids	=kg.	1,3	1,6	2,5

Carica batterie compatti portatili

Caratteristiche

- Protezione termostatica a riarmo automatico (Mach 116, 119)
- Protezione contro le inversioni di polarità
- Protezione contro i corto circuiti alle pinze
- Arresto manuale della carica

Portable battery chargers

Features

- Overload protection with automatic reset (Mach 116, 119)
- Inversions of polarity protection
- Short circuits on the clamps protection
- Manual charge breaker

Chargeurs de batterie portatils

Caractéristiques

- Protection à réarmement automatique contre les surcharges (Mach 116, 119)
- Protection contre les inversions de polarité
- Protection contre les court circuits aux pinces
- Arrêt manuel de la charge

1
PHASE



FUSE



MACH 113		
fuse 4A	(10 pcs)	010280
MACH 114 - 214		
fuse 5A	(10 pcs)	010281

MACH 113



12 Volt
10 - 40 Ah

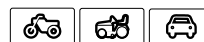

MACH 114



12 Volt
15 - 60 Ah



MACH 214



6 - 12 Volt
15 - 60 Ah

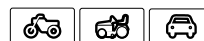

MACH 116



12 Volt
20 - 90 Ah



MACH 119



12 Volt
10 - 120 Ah



Caratteristiche tecniche	Technical specifications	Données techniques		MACH 113	MACH 114	MACH 214	MACH 116	MACH 119
Alimentazione	Input voltage	Tension d'alimentation	Volt 50-60Hz (AC)	1 Ph x 230	1 Ph x 230	1 Ph x 230	1 Ph x 230	1 Ph x 230
Potenza	Power	Puissance	W	40	50	50	80	110
Tensione nominale batteria	Nominal battery voltage	Tension nominale de la batterie	Volt	12	12	6 / 12	12	12
Corrente di carica media	Average charging current	Courant de charge moyen	Amp.	1,5	2,5	2,5	4,0	6,0
Corrente di carica efficace	Effective charging current	Courant de charge effectif	Amp.	3	4	4	6	9
Posizioni di carica	Charging positions	Positions de charge	N°	1	1	1	1	2
Capacità batteria	Battery capacity	Capacité batteries	Ah min/max	10 / 40	15 / 60	15 / 60	20 / 90	10 / 120
Dimensioni	Dimensions	Dimensions	mm.	225 x 160 x 95				
Peso	Weight	Poids	=kg.	1,3	1,3	1,3	1,5	1,5

CLASS Series

Carica batterie portatili

Caratteristiche

- Regolazione della corrente di carica
- Protezione termostatica
- Protezione contro i corto circuiti
- Protezione contro le inversioni di polarità
- Arresto manuale della carica
- **CU**: 100% Avvolgimenti in rame (Class 12A, 16A, 30A, 50A)

Portable battery chargers

Features

- Charging current regulation
- Overload protection
- Short circuits protection
- Inversions of polarity protection
- Manual charge breaker
- **CU**: 100% Copper windings (Class 12A, 16A, 30A, 50A)

Chargeurs de batterie portatifs

Caractéristiques

- Régulation du courant de charge
- Protection contre les surcharges
- Protection contre les court circuits
- Protection contre les inversions de polarité
- Arrêt manuel de la charge
- **CU**: 100% Bobinage en cuivre (Class 12A, 16A, 30A, 50A)



CLASS 20A  12 - 24 Volt
10 - 250 Ah



CLASS 12A  12 - 24 Volt
15 - 140 Ah



CLASS 16A  12 - 24 Volt
20 - 200 Ah



FUSE



CLASS 12A

fuse 15A (10 pcs) 010293

CLASS 16A

fuse 20A (10 pcs) 010300

CLASS 20A

fuse 30A (10 pcs) 010295

Caratteristiche tecniche	Technical specifications	Données techniques		CLASS 12A CU	CLASS 16A CU	CLASS 20A
Alimentazione	Input voltage	Tension d'alimentation	Volt 50-60Hz (AC)	1 Ph x 230	1 Ph x 230	1 Ph x 230
Potenza	Power	Puissance	W	130	220	300
Tensione nominale batteria	Nominal battery voltage	Tension nominale de la batterie	Volt	12 / 24	12 / 24	12 / 24
Corrente di carica media	Average charging current	Courant de charge moyen	Amp.	6	9	12
Corrente di carica efficace	Effective charging current	Courant de charge effectif	Amp.	9	12	20
Posizioni di carica	Charging positions	Positions de charge	N°	2	2	2
Capacità batteria	Battery capacity	Capacité batteries	Ah min/max	15 / 140	20 / 200	10 / 250
Dimensioni	Dimensions	Dimensions	mm.	200 x 190 x 270		
Peso	Weight	Poids	=kg.	4,0	4,5	6,0





CLASS 50A  12 - 24 Volt
15 - 500 Ah





CLASS 30A  12 - 24 Volt
20 - 300 Ah



FUSE 
CLASS 30A
fuse 40A (10 pcs) 010278

FUSE 
CLASS 50A
fuse 50A (10 pcs) 010296

Caratteristiche tecniche	Technical specifications	Données techniques		CLASS 30A 	CLASS 50A 
Alimentazione	Input voltage	Tension d'alimentation	Volt 50-60Hz (AC)	1 Ph x 230	1 Ph x 230
Potenza	Power	Puissance	W	600	1000
Tensione nominale batteria	Nominal battery voltage	Tension nominale de la batterie	Volt	12 / 24	12 / 24
Corrente di carica media	Average charging current	Courant de charge moyen	Amp.	20	35
Corrente di carica efficace	Effective charging current	Courant de charge effectif	Amp.	30	50
Posizioni di carica	Charging positions	Positions de charge	N°	2	4
Capacità batteria	Battery capacity	Capacité batteries	Ah min/max	20 / 300	15 / 500
Dimensioni	Dimensions	Dimensions	mm.	200 x 190 x 270	340 x 300 x 160
Peso	Weight	Poids	≈kg.	7,5	11,8

CLASS Booster Series

Carica batterie con avviatore rapido

Caratteristiche

- Regolazione della corrente di carica
- Protezione termostatica
- Protezione contro i corto circuiti
- Protezione contro le inversioni di polarità
- Arresto manuale della carica
- **CU:** 100% Avvolgimenti in rame (Class Booster 410A)

Battery chargers and starter

Features

- Charging current regulation
- Overload protection
- Short circuits protection
- Inversions of polarity protection
- Manual charge breaker
- **CU:** 100% Copper windings (Class Booster 410A)

Chargeurs de batterie avec démarrage rapide

Caractéristiques

- Régulation du courant de charge
- Protection contre les surcharges
- Protection contre les court circuits
- Protection contre les inversions de polarité
- Arrêt manuel de la charge
- **CU:** 100% Bobinage en cuivre (Class Booster 410A)



CLASS Booster 150A



12 Volt
20 - 200 Ah



CLASS Booster 220A



12 - 24 Volt
20 - 300 Ah



CLASS Booster 410A



12 - 24 Volt
15 - 500 Ah



FUSE



CLASS Booster 150A

fuse 50A (10 pcs) 010296

CLASS Booster 220A

fuse 80A (10 pcs) 010297

CLASS Booster 410A

fuse 100A (12 pcs) 010292

Caratteristiche tecniche	Technical specifications	Données techniques		CLASS BOOSTER 150A	CLASS BOOSTER 220A	CLASS BOOSTER 410A CU
Alimentazione	Input voltage	Tension d'alimentation	Volt 50-60Hz (AC)	1 Phx230	1 Ph x 230	1 Ph x 230
Potenza	Power	Puissance	KW	0,2 / 1,2	0,5 / 3	1 / 3,5
Tensione nominale batteria	Nominal battery voltage	Tension nominale de la batterie	Volt	12	12 / 24	12 / 24
Corrente di carica media	Average charging current	Courant de charge moyen	Amp.	12	13	35
Corrente di carica efficace	Effective charging current	Courant de charge effectif	Amp.	18	20	50
Posizioni di carica	Charging positions	Positions de charge	N°	2	2	2
Corrente di avviamento	Boosting current	Courant de démarrage	Amp. 0 Volt (CC)	135	230	450
Corrente di avviamento	Boosting current	Courant de démarrage	Amp. 1 Volt EL	100	150	330
Capacità batteria	Battery capacity	Capacité batteries	Ah min/max	20 / 200	20 / 300	15 / 500
Dimensioni	Dimensions	Dimensions	mm.	200 x 190 x 270	340 x 300 x 160	
Peso	Weight	Poids	=kg.	6,5	11,0	11,8



1
PHASE



**CLASS
Booster
300E**

 12 - 24 Volt
25 - 350 Ah



**CLASS
Booster
350E**

 12 - 24 Volt
30 - 400 Ah



**CLASS
Booster
400E**

 12 - 24 Volt
35 - 500 Ah



FUSE 

CLASS Booster 300E
fuse 80A (10 pcs) 010297

CLASS Booster 350E
fuse 50A (10 pcs) 010296

CLASS Booster 400E
fuse 50A+80A
(10+10 pcs) 010296+010297

Caratteristiche tecniche	Technical specifications	Données techniques		CLASS BOOSTER 300E	CLASS BOOSTER 350E	CLASS BOOSTER 400E
Alimentazione	Input voltage	Tension d'alimentation	Volt 50-60Hz (AC)	1 Ph x 230	1 Ph x 230	1 Ph x 230
Potenza	Power	Puissance	KW	0,7 / 3,5	1,1 / 5	1,3 / 6
Tensione nominale batteria	Nominal battery voltage	Tension nominale de la batterie	Volt	12 / 24	12 / 24	12 / 24
Corrente di carica media	Average charging current	Courant de charge moyen	Amp.	14	20	26
Corrente di carica efficace	Effective charging current	Courant de charge effectif	Amp.	20	35	40
Posizioni di carica	Charging positions	Positions de charge	N°	2	4	4
Corrente di avviamento	Boosting current	Courant de démarrage	Amp. 0 Volt (CC)	250	300	400
Corrente di avviamento	Boosting current	Courant de démarrage	Amp. 1 Volt EL	160	220	270
Capacità batteria	Battery capacity	Capacité batteries	Ah min/max	25 / 350	30 / 400	35 / 500
Dimensioni	Dimensions	Dimensions	mm.	400 x 300 x 640		
Peso	Weight	Poids	=kg.	13,5	15,5	18,0

CLASS Booster Series

Carica batterie con avviatore rapido

Caratteristiche

- Carica con timer
- Comando a distanza per l'avviamento (1350, 2500)
- Protezione termostatica
- Protezione contro i corto circuiti
- Protezione contro le inversioni di polarità
- Arresto manuale della carica
- **CU**: 100% Avvolgimenti in rame (Class Booster 2500)

Battery chargers and starter

Features

- Fast charging with timer
- Boosting remote control (1350, 2500)
- Overload protection
- Short circuits protection
- Inversions of polarity protection
- Manual charge breaker
- **CU**: 100% Copper windings (Class Booster 2500)

Chargeurs de batterie avec démarrage rapide

Caractéristiques

- Charge rapide avec temporisateur
- Commande à distance pour le démarrage (1350,2500)
- Protection contre les surcharges
- Protection contre les court circuits
- Protection contre les inversions de polarité
- Arrêt manuel de la charge
- **CU**: 100% Bobinage en cuivre (Class Booster 2500)



FUSE



CLASS Booster 4500 - 5000
fuse 100A (12 pcs) 010292

CLASS Booster 4500



12 - 24 Volt
35 - 600 Ah



CLASS Booster 5000



12 - 24 Volt
35 - 800 Ah



Caratteristiche tecniche	Technical specifications	Données techniques		1 PHASE CLASS BOOSTER 4500	1 PHASE CLASS BOOSTER 5000
Alimentazione	Input voltage	Tension d'alimentation	Volt 50-60Hz (AC)	1 Ph x 230	1 Ph x 230
Potenza	Power	Puissance	KW	1,7 / 7,5	2,3 / 11
Tensione nominale batteria	Nominal battery voltage	Tension nominale de la batterie	Volt	12 / 24	12 / 24
Corrente di carica media	Average charging current	Courant de charge moyen	Amp.	50	70
Corrente di carica efficace	Effective charging current	Courant de charge effectif	Amp.	75	105
Posizioni di carica	Charging positions	Positions de charge	N°	4	4
Corrente di avviamento	Boosting current	Courant de démarrage	Amp. 0 Volt (CC)	500	700
Corrente di avviamento	Boosting current	Courant de démarrage	Amp. 1 Volt EL	350	460
Capacità batteria	Battery capacity	Capacité batteries	Ah min/max	35 / 600	35 / 800
Dimensioni	Dimensions	Dimensions	mm.	470 x 320 x 750	
Peso	Weight	Poids	≈kg.	25,5	28,0



1
PHASE

3
PHASE



TIMER



CE

PG



FUSE

CLASS Booster 1350 - 2500
fuse 200A (12 pcs) 010287

**CLASS
Booster
1350**

12 - 24 Volt
35 - 1300 Ah



**CLASS
Booster
2500**

12 - 24 Volt
25 - 2200 Ah



Caratteristiche tecniche	Technical specifications	Données techniques		CLASS BOOSTER 1350	CLASS BOOSTER 2500
Alimentazione	Input voltage	Tension d'alimentation	Volt 50-60Hz (AC)	3 Ph x 230/400	3 Ph x 230/400
Potenza	Power	Puissance	KW	2,5 / 20	4 / 42
Tensione nominale batteria	Nominal battery voltage	Tension nominale de la batterie	Volt	12 / 24	12 / 24
Corrente di carica media	Average charging current	Courant de charge moyen	Amp.	90 / 100	130 / 180
Corrente di carica efficace	Effective charging current	Courant de charge effectif	Amp.	90 / 100	130 / 180
Posizioni di carica	Charging positions	Positions de charge	N°	5	10
Corrente di avviamento	Boosting current	Courant de démarrage	Amp. 0 Volt (CC)	1350	2500
Corrente di avviamento	Boosting current	Courant de démarrage	Amp. 1 Volt EL	800	1500
Capacità batteria	Battery capacity	Capacité batteries	Ah min/max	35 / 1300	25 / 2200
Dimensioni	Dimensions	Dimensions	mm.	470 x 320 x 750	590 x 380 x 840
Peso	Weight	Poids	=kg.	44,0	73,0

Maschere per saldatura con filtro auto-oscurante

Welding helmets with Auto Darkening Filter

Masques avec filtre de soudage automatique

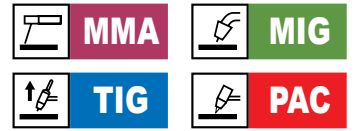

Qualità e prestazioni al giusto prezzo

Le maschere Deca sono la scelta ideale per i saldatori hobbisti, agricoltori, manutentori ed addetti alle costruzioni che, pur saldando occasionalmente, non vogliono rinunciare alla comodità di vedere con chiarezza pur mantenendo la maschera di fronte al volto.

Quality and performance at a fair price

Deca helmets are the ideal auto-darkening shield for hobby welders, farmers and maintenance or construction workers that, while occasionally welding, do not want to give up the convenience of seeing clearly, keeping the helmet in front of the face.

Qualité et performance au juste prix

Les masques Deca sont l'idéal pour les soudeurs amateurs, les agriculteurs, les travailleurs de l'entretien ou de la construction, qui, bien que soudent rarement, ne veulent pas renoncer à la commodité de voir clairement, en gardant la masque à l'avant du visage.



WM 25



LCD 11 DIN

WM 30



LCD 9>13 DIN



WM 28



LCD 9>13 DIN





WM 25

010332 WM 25 DIN 11

- Valore di filtro scuro: fisso 11
- Valore di filtro chiaro: 3
- Adatta per i principali processi di saldatura: MMA, MIG e molte applicazioni TIG (> 20Amp).
- Single dark shade of 11 and light shade of 3
- For most arc welding process such as MMA, MIG and many TIG application (> 20Amp).
- Teinte foncée fixe de 11 et une teinte claire de 3
- Convenient à la plupart des procédés de soudage à l'arc tels que MMA, MIG et de nombreuses applications TIG (> 20Amp)



WM 25 - 28 - 30

Protezione filtro esterna
Outside impact resistance
Lentille de protection extérieur

101337 (10 pcs)



WM 28

010324 WM 28 DIN 9-13

- Valore di filtro scuro: regolabile da 9 a 13
 - Valore di filtro chiaro: 4
 - La regolazione è all'esterno della maschera.
 - Due livelli di sensibilità per un migliore rilevamento dell'arco.
 - Adatta per i principali processi di saldatura: MMA, MIG e molte applicazioni TIG.
- Ideale per chi cambia occasionalmente il metodo di saldatura.

- Selectable dark shade from shade 9 to 13 and light shade of 4
 - The setting is outside the mask.
 - Two sensitivity levels for a better arc detection.
 - For most arc welding process such as MMA, MIG and many TIG application.
- Best choice for those who change occasionally welding process.

- Teinte foncée réglable de 9 à 13 et une teinte claire de 4
 - L'ajustement est en dehors du masque.
 - Deux niveaux de sensibilité pour une meilleure détection de l'arc.
 - Convenient à la plupart des procédés de soudage à l'arc tels que MMA, MIG et de nombreuses applications TIG.
- Meilleur choix pour personnes qui changent occasionnellement procédé de soudage.



WM 30

010326 WM 30 DIN 9-13

- Valore di filtro scuro: regolabile da 9 a 13
 - Valore di filtro chiaro: 4
 - Livello di sensibilità regolabile per un migliore rilevamento dell'arco.
 - Adatta per i principali processi di saldatura: MMA, MIG e molte applicazioni TIG.
- Ideale per chi cambia occasionalmente il sistema di saldatura.

- Selectable dark shade from shade 9 to 13 and light shade of 4
 - Adjustable sensitivity level for a better arc detection.
 - For most arc welding process such as MMA, MIG and many TIG application.
- Best choice for those who change occasionally welding process

- Teinte foncée réglable de 9 à 13 et une teinte claire de 4
 - Permettent de ajuster la sensibilité pour une meilleure détection de l'arc.
 - Convenient à la plupart des procédés de soudage à l'arc tels que MMA, MIG et de nombreuses applications TIG.
- Meilleur choix pour personnes qui changent occasionnellement procédé de soudage.

Caratteristiche tecniche	Technical specifications	Données techniques		WM 25	WM 28	WM 30
Campo di visuale	Viewing area	Champ visuel	mm	97 x 47	97 x 44	97 x 47
Protezione da ultravioletto/infrarosso	Ultraviolet/infrared protection	Protection ultraviolettes / infrarouges		15 (ad ogni regolazione / at any setting / à chaque réglage)		
Grado protezione (Filtro spento)	Light shade (Filter off)	Niveau de protection (filtre non actif)	DIN	3	4	4
Grado protezione (Filtro attivo)	Light shade (Filter on)	Niveau de protection (filtre actif)	DIN	11	9 >13 (regolabile / adjustable / réglables)	9 >13 (regolabile / adjustable / réglables)
Tempo di commutazione da chiaro a scuro	Switching time light to dark	Temp de commutation de clair à obscure	DIN	1/10.000	1/10.000	1/25.000
Tempo di commutazione da scuro a chiaro	Switching time dark to light	Temp de commutation de obscure à clair	sec	0,25-0,45	0,25-0,45 / 0,65-0,80	0,35 - 0,45
Sensibilità	Sensitivity	Sensibilité	sec	FIX	MIN / MAX	regolabile / adjustable / réglables
Sensore d'arco	Arc sensor	Détecteur d'arc	N°	2	2	2
Alimentazione	Power supply	Alimentation		cella solare / solar cells / cellule solaire		
Temperatura di esercizio	Operating temperature	Température de service	°C	-5 / +55	-10 / +55	-10 / +55
Optical class	Optical class	Optical class	EN 379	1 / 1 / 1 / 3	1 / 2 / 1 / 2	1 / 1 / 1 / 2
Protezione filtro	Cover lenses	Lentille de protection		interna - esterna / inside - outside / intérieur - extérieur		
Resistenza agli urti	Impact resistance	Résistance à l'impact		EN 175		
Peso	Weight	Poids	gr.	430	492	430
MMA / MIG MAG	MMA / MIG MAG	MMA / MIG MAG		✓	✓	✓
TIG	TIG	TIG		✓(>20A)	✓	✓



Maschere per saldatura con filtro inattinico

Welding masks with adiactinic filter

Masques de soudage avec filtre adiactinic



WM 22

010322 WM 22

- Valore filtro inattinico: 11
- Dimensione filtro mm 60 x 110
- Adatta per i principali processi di saldatura: MMA, MIG e molte applicazioni TIG (> 20Amp).
- Resistenza agli urti EN 175: SW

- Adiactinic filter value: 11
- Filter dimension mm 60 x 110
- For most arc welding process such as MMA, MIG and many TIG application (> 20Amp).
- Impact resistance EN 175: SW

- Valeur filtre adiactinic: 11
- Filter dimension mm 60 x 110
- Convenient à la plupart des procédés de soudage à l'arc tels que MMA, MIG et de nombreuses applications TIG (> 20Amp)
- Résistance à l'impact EN 175: SW

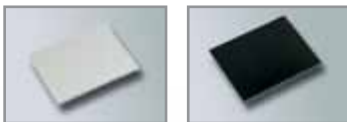

WM 22

Vetro trasparente - Transparent glass
Verre transparent

010335 (4 pcs) 60 x 110 mm Blister

Vetro inattinico - Adiactinic glass
Verre inattinique DIN 11

010347 (2 pcs) 60 x 110 mm Blister



WM 20

010320 WM 20

- Valore filtro inattinico: 11
- Dimensione filtro mm 75 x 98
- Adatta per i principali processi di saldatura: MMA, MIG e molte applicazioni TIG (> 20Amp).
- Resistenza agli urti EN 175: SW

- Adiactinic filter value: 11
- Filter dimension mm 75 x 98
- For most arc welding process such as MMA, MIG and many TIG application (> 20Amp).
- Impact resistance EN 175: SW

- Valeur filtre adiactinic: 11
- Filter dimension mm 75 x 98
- Convenient à la plupart des procédés de soudage à l'arc tels que MMA, MIG et de nombreuses applications TIG (> 20Amp)
- Résistance à l'impact EN 175: SW

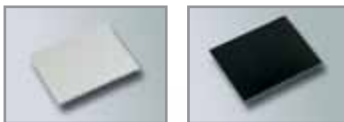

WM 20 - 18

Vetro trasparente - Transparent glass
Verre transparent

010338 (4 pcs) 75 x 98 mm Blister

Vetro inattinico - Adiactinic glass
Verre inattinique DIN 11

010339 (2 pcs) 75 x 98 mm Blister



WM 18

010319 WM 18

- Valore filtro inattinico: 11
- Dimensione filtro mm 75 x 98
- Adatta per i principali processi di saldatura: MMA, MIG e molte applicazioni TIG (> 20Amp).
- Resistenza agli urti EN 175: SW

- Adiactinic filter value: 11
- Filter dimension mm 75 x 98
- For most arc welding process such as MMA, MIG and many TIG application (> 20Amp).
- Impact resistance EN 175: SW

- Valeur filtre adiactinic: 11
- Filter dimension mm 75 x 98
- Convenient à la plupart des procédés de soudage à l'arc tels que MMA, MIG et de nombreuses applications TIG (> 20Amp)
- Résistance à l'impact EN 175: SW



DECA Accessori



Presentare il prodotto
 Questi prodotti sono in confezione da espositore

Exposing the product
 These products are in display pack

Exposer le produit
 Ces produits sont en pack d'affichage



Blister Display Concept
 019001 cm 100 x 50 x 201,5



Displayer Concept
 5 ripiani - 5 shelves - 5 etagères
 019006 cm 66 x 47 x 102



Displayer Concept
 3 ripiani - 3 shelves - 3 etagères
 019004 cm 66 x 47 x 102

Consumabili Deca per prestazioni superiori

Deca consumable for higher performance

Consumables Deca pour plus des performances



Elettrodi rutili per acciai non legati e basso legati.

Caratteristiche

Innesco facile.
Ottimo aspetto del cordone e facile rimozione della scoria.

Settori applicativi

Costruzioni metalliche in genere.
Carpenteria leggera.
Riparazioni.

Rutile electrodes for unalloyed and low alloyed steels.

Features

Easy initiation.
Excellent bead appearance and easy slag removal.

Main application

General structural work.
Light carpentry.
Repairing.

Electrodes rutili pour aciers non alliés et faiblement alliés.

Caractéristiques

Amorçage faciles.
Très bel aspect des cordons.
Très bon décaissage du laitier.

Applications principales

Charpente métallique.
Construction métallique.
Réparation.



Elettrodi basici a basso contenuto di idrogeno.

Caratteristiche

Fusione senza spruzzi.
Innesco abbastanza facile.
Deposito regolare.
Facile da pulire.

Settori applicativi

Elettrodi per applicazioni dove sono richieste ottime proprietà meccaniche.

Basic electrodes (low hydrogen).

Features

Melting without spatter.
Quite easy initiation.
Regular cords.
Easy cleaning.

Main application

Electrodes for applications requiring high mechanical strength.

Electrodes basique avec faible teneur en hydrogène.

Caractéristiques

Fusion sans projections.
Amorçage relativement faciles.
Cordon réguliers.
Décaissage facile.

Applications principales

Electrodes pour applications nécessitant des résistances mécaniques importantes.



Elettrodi rutili per acciai inox (19Cr-10Ni).

Caratteristiche

Fusione senza spruzzi.
Deposito regolare.
Facile da pulire.

Settori applicativi

Utilizzato per la saldatura dell'acciaio inox tipo AISI 304 ed in tutte le costruzioni dove è richiesta una buona resistenza alla corrosione ed ossidazione.

Rutile electrodes for stainless steel (19Cr-10Ni).

Features

Melting without spatter.
Regular cords.
Easy cleaning.

Main application

Used for welding of stainless steel AISI 304 and in all constructions which require a good resistance to corrosion and oxidation.

Electrodes rutili pour Aciers inox (19Cr-10Ni).

Caractéristiques

Fusion sans projections.
Cordon réguliers.
Décaissage facile.

Applications principales

Utilisé pour la soudure en acier inox AISI 304 et dans tous les constructions qui nécessitent une bonne résistance à la corrosion et l'oxydation.



Elettrodo con rivestimento basico-grafitico per saldare ghisa senza o con basso preriscaldamento (300°C).

Caratteristiche

Per riparazioni di pezzi in ghisa o per unire pezzi in acciaio rame o nickel alle fusioni.

Innesco facile.
Superficie del cordone liscia.

Settori applicativi

Riparazioni.

Basic-graphite coated MMA electrode with a pure nickel core wire for welding cast iron without or with low preheating (max. +300°C).

Features

For repair welding of cracked cast iron parts or joining components made of steel, copper or nickel materials to casting.

Easy arc striking and restriking.
Smooth bead surface.

Main application

Repairing.

Electrode basique-graphite pour le soudage de fonte avec peu ou pas de préchauffage (300°C).

Caractéristiques

Pour le soudage de réparation des pièces fissurées en fonte ou en joignant les composants en matériaux en acier, cuivre ou de nickel à la coulée.

Amorçage faciles.
Très bel aspect des cordons.

Applications principales

Réparation.

Code Code Référence	Diametro Diameter Diamètre	Lunghezza Length Longueur	Quantità Quantity Quantité	Intensità corrente Current intensity Intensité du courant	Classificazione Classification Classification	Posizioni di saldatura Welding position Positions de soudage	Tipo di corrente Type of current Nature du courant
Elettrodo rutilico Rutile electrodes Electrodé rutilique					AWS A5.1 E6013 EN 499 E 42 0 RR 12		DC AC U0 ≥ 48 Volt
010220	1,6 mm	300 mm	40	20 - 40 Amp			
010224	1,6 mm	300 mm	100	20 - 40 Amp			
010221	2,0 mm	300 mm	40	40 - 60 Amp			
010225	2,0 mm	300 mm	80	40 - 60 Amp			
010222	2,5 mm	300 mm	30	60 - 90 Amp			
010125	2,5 mm	300 mm	55	60 - 90 Amp			
010223	3,2 mm	350 mm	16	90 - 120 Amp			
010126	3,2 mm	350 mm	30	90 - 120 Amp			
Elettrodo basico Basic electrodes Electrodé basique					E7018-1 EN 499 E 464 B 32 H 5		DC AC U0 ≥ 55 Volt
010127	2,5 mm	300 mm	30	70 - 90 Amp			
Elettrodo acciaio inox Stainless steel electrodes Electrodé acier inox					AWS A5.4 E 308L-17 EN 1600 E 19 9 LR 32		DC AC U0 ≥ 50 Volt
010128	2,0 mm	300 mm	40	35 - 50 Amp			
010129	2,5 mm	300 mm	30	50 - 80 Amp			
Elettrodo ghisa Cast iron electrodes Electrodé fonte					AWS A5.15 Eni-CI EN 1071 E C Ni-CI 1		DC AC U0 ≥ 50 Volt
010131	2,5 mm	300 mm	6	60 - 90 Amp			
010130	2,5 mm	300 mm	16	60 - 90 Amp			

Consumabili Deca per prestazioni superiori

Deca consumable for higher performance

Consumables Deca pour plus des performances



Acciaio

Di impiego generale, indicato per l'unione di acciai al carbonio comuni. Da impiegarsi nella carpenteria in genere, serbatoi, carrozzerie, ecc.

Steel

Suitable for the joint of unalloyed carbon steels. To be used for steel structures in general, carbody repair, tanks, etc.

Acier

Convient pour le joint des aciers au carbone non allié. Pour être utilisé pour des structures en acier, en général, la réparation Carrosseries, citernes, etc



Alluminio/Magnesio 5%

Filo pieno in alluminio indicato per la saldatura di leghe contenenti fino al 5% di magnesio. Trova impiego nella costruzione di strutture per la cantieristica navale, nel ferroviario, nel settore automobilistico e nella costruzione di serbatoi.

Aluminum/Magnesium 5%

Solid aluminium wire suitable for welding alloys containing up to 5% magnesium, used in the construction of structures in shipbuilding, railways, automotive and tank sector.

Aluminium/Magnesium 5%

Fil d'aluminium solide, convient pour le soudage des alliages contenant jusqu'à 5% de magnésium. Il est utilisé dans la construction navale, le ferroviaire, le secteur automobile et le réservoir.



Alluminio/Silicio 5%

Filo pieno in alluminio al 5% di Si. Indicato per la saldatura di leghe Al-Si 2-7%, e leghe Al-Mg-Si. Trova impiego nella costruzione di strutture per impieghi architettonici, cassoni per autotreni, serbatoi e per la riparazione di fusioni.

Aluminum/Silicium 5%

Solid aluminium wire with 5% Si. Suitable for welding Al Si 2-7% alloys, and Al-Mg-Si alloys. It is used in the construction of structures for architectonic uses, trailer-truck bodies, tanks and casting repair.

Aluminium/Silicium 5%

Fil d'aluminium solide avec Si 5%. Convient pour le soudage des alliages Al Si 2-7%, et Al-Mg-Si. Il est utilisé dans la construction de structures pour des usages architectonique, remorque-corps de camion, citernes et la réparation de fusions.



Inox

Filo pieno idoneo alla saldatura di acciai inossidabili del tipo AISI 301, 304 e 304L. Ottima resistenza alla corrosione.

Stainless Steel

Solid wire suitable for welding stainless steels AISI 301, 304 and 304L type. Excellent resistance to corrosion.

Acier inoxydable

Fil solide approprié pour le soudage des aciers inoxydables AISI 301, 304 et 304L type. Excellente résistance à la corrosion.



Animato

Filo Animato autoprotetto multiposizionale ideale per saldature single-pass su acciaio al carbonio.

Self-shielded

All positional self-shielded wire, ideal single-pass welding of carbon steel.

Fourré

Fil fourré pour souder en tous les positionne, idéal pour soudage de l'acier au carbone en un seul passage.



Rame/Silicio 3%

Filo pieno idoneo alla saldatura di leghe rame-silicio o rame-zinco. Particolarmente indicato per la saldatura delle lamiere zincate nel settore carrozzeria.

Copper/Silicium 3%

Solid wire suitable for welding of copper-zinc or copper-silicon. Particularly suitable for brazing of galvanized sheet metal in the bodywork.

Cuivre/Silicium 3%

Fil plein pour le soudage des alliages cuivre-zinc ou de cuivre-silicium. Particulièrement adaptée pour le brasage de tôles galvanisées en la réparation de carrosserie de automobile.

Code Code Référence	Diametro Diameter Diamètre	Bobina Spool Bobine	Quantità Quantity Quantité	Intensità corrente Current intensity Intensité du courant	Gas di protezione Shielding gas Gaz de protection	Classificazione Classification Classification	Tipo di corrente Type of current Nature du courant
Acciaio - Steel - Acier					Argon/CO ₂ CO ₂	AWS A5.18: ER 70S-6 EN ISO 14341-A: G 42 2 M G3Si1	DC +
010871	ø 0,6	ø mm. 100	0,7 kg.	30 - 100 Amp			
010801	ø 0,6	ø mm. 200	5,0 kg.	30 - 100 Amp			
010872	ø 0,8	ø mm. 100	0,7 kg.	60 - 200 Amp			
010805	ø 0,8	ø mm. 200	5,0 kg.	60 - 200 Amp			
Alluminio/Magnesio 5% - Aluminium/Magnesium 5%					Argon	AWS A5.10: ER 5356 EN ISO 18273: S Al 5356 (AlMg5Cr(A))	DC +
010881	ø 0,8	ø mm. 100	0,4 kg.	60 - 170 Amp			
010882	ø 1,0	ø mm. 100	0,4 kg.	90 - 210 Amp			
Alluminio/Silicio 5% - Aluminium/Silicon 5%					Argon	AWS A5.10: ER 4043 EN ISO 18273: S Al 4043 (AlSi5(A))	DC +
010844	ø 1,0	ø mm. 100	0,5 kg.	90 - 210 Amp			
Inox - Stainless Steel - Acier inoxydable					Argon Argon/O ₂	AWS A5.9: ER 308L Si EN ISO 14343-A: G 19 9 L Si	DC +
010892	ø 0,8	ø mm. 100	0,7 kg.	65 - 220 Amp			
Animato - Self-shielded - Fourré					xx	AWS A5.20: E71T-GS	DC -
010818	ø 0,9	ø mm. 100	0,7 kg.	40 - 100 Amp			
010816	ø 0,9	ø mm. 200	2,0 kg.	40 - 100 Amp			
Rame/Silicio 3% - Copper/Silicium 3% - Cuivre/Silicium 3%					Argon	AWS A5.7: ER CuSi-A EN ISO 14640: S CuSi3Mn1 - S Cu6560	DC +
010845	ø 0,8	ø mm. 200	2,0 kg.	65 - 220 Amp			

Il giusto accessorio per ogni macchina

The right accessory for each equipment

Le droit accessoire pour chaque équipement



Modello Model Modèle	A Kit di saldatura MMA - MMA Welding Kit - Kit soudage MMA								B Porta elettrodi Electrode holder Pince porte electrodes	C Morsetto massa Earth clamp Pince de masse	D Cavo Cable Câble	E Attacchi Socket Connecteur
	AD10 (000199)	DS10 (000200)	DS16 (000201)	DS20 (000217)	DS25S (000220)	DS35 (000205)	DS50 (000207)	DS60 (000209)				
SIL 208	-	-	-	-	-	-	-	-	010301	010310	-	-
SIL 313	-	✓	-	-	-	-	-	-	010301	010310	010353	010385
SIL 415	-	✓	-	-	-	-	-	-	010301	010310	010353	010385
SIL 417	-	-	✓	-	-	-	-	-	010303	010311	010357	010385
Mos EVO Series	-	✓	-	-	-	-	-	-	010301	010310	010353	010385
Mos 210 GEN	-	-	✓	-	-	-	-	-	010301	010310	010353	010385
Mos GEN Series	-	✓	-	-	-	-	-	-	010303	010311	010357	010385
Mastro EVO Series	-	-	-	✓	-	-	-	-	010303	010311	010358	010385
Mastro HD Series	-	-	-	-	✓	-	-	-	010303	010311	010358	010386
Mastro 627	-	-	-	-	-	✓	-	-	010307	010315	010359	010386
Tecno Series	-	-	-	-	-	-	-	-	010301	010310	-	-
Star Series	-	-	-	-	-	-	-	-	010301	010310	-	-
Star 270E	-	-	-	-	-	-	-	-	010303	010311	-	-
Parva E Series	-	-	-	-	-	-	-	-	010301	010310	-	-
Parva 175E	✓	-	-	-	-	-	-	-	010301	010310	010353	010340
Domus 171E	-	-	-	-	-	-	-	-	010301	010310	-	-
Domus 175E	✓	-	-	-	-	-	-	-	010301	010310	010353	010340
T-Arc 520	-	-	✓	-	-	-	-	-	010303	010311	010357	010385
T-Arc 525	-	-	-	✓	-	-	-	-	010303	010311	010358	010385
T-Arc 527	-	-	-	✓	-	-	-	-	010303	010311	010358	010385
T-Arc 529	-	-	-	✓	-	-	-	-	010303	010311	010358	010385
T-Arc 530	-	-	-	-	-	✓	-	-	010307	010315	010359	010386
T-Arc 845	-	-	-	-	-	-	✓	-	010304	010317	010360	010387
P-Arc 525	-	-	-	✓	-	-	-	-	010303	010311	010358	010385
P-Arc 526	-	-	-	-	-	✓	-	-	010307	010315	010359	010386
P-Arc 735	-	-	-	-	-	✓	-	-	010307	010315	010359	010386
P-Arc 840	-	-	-	-	-	-	✓	-	010304	010317	010360	010387
P-Arc 846	-	-	-	-	-	-	✓	-	010304	010317	010360	010387
E-Arc 840	-	-	-	-	-	-	✓	-	010304	010315	010360	010387
E-Arc 860	-	-	-	-	-	-	-	✓	010306	010317	010361	010387
SILTIG 415	-	✓	-	-	-	-	-	-	010301	010310	010353	010385
Mastrotig 200	-	-	-	✓	-	-	-	-	010303	010311	010358	010385
Mastrotig 218 DC	-	-	-	✓	-	-	-	-	010303	010311	010358	010385
Mastrotig 216 AC/DC	-	-	-	✓	-	-	-	-	010303	010311	010358	010385
Mastrotig 327 AC/DC	-	-	-	-	-	✓	-	-	010307	010315	010359	010386
Decatig 200E	-	-	-	-	-	✓	-	-	010307	010315	019359	010386

MMA

TIG



AD 10 Welding Kit 160A
000199 (1 pc) 2,4+1,6m 16 mmq



DS10 Welding Kit 160A
000200 (1 pc) 3+2m 25 mmq

DS16 Welding Kit 180A
000201 (1 pc) 3+2m 25 mmq

DS20 Welding Kit 200A
000217 (1 pc) 3+2m 25 mmq

DS25S Welding Kit 200A
000220 (1 pc) 3+2m 50 mmq

DS35 Welding Kit 350A
000205 (1 pc) 3+3m 50 mmq

DS50 Welding Kit 500A
000207 (1 pc) 3+3m 70 mmq

DS60 Welding Kit 600A
000209 (1 pc) 3+3m 70 mmq



Pinze porta elettrodi - Electrode holders
Pinces porte electrodes

010301	160A	200A@35%	(1 pc)
010303	200A	200A@35%	(1 pc)
010307	300A	300A@35%	(1 pc)
010304	400A	400A@35%	(1 pc)
010306	600A	600A@35%	(1 pc)



Morsetti di massa - Earth clamps
Pinces de masse

010310	160A	(1 pc)
010311	200A 200A@35%	(1 pc)
010315	350A 350A@35%	(1 pc)
010317	500A 500A@35%	(1 pc)



Cavo - Cable - Câble

010353	10mm ² (10m)	(1 pc)
010357	16mm ² (10m)	(1 pc)
010358	25mm ² (10m)	(1 pc)
010359	35mm ² (10m)	(1 pc)
010360	50mm ² (10m)	(1 pc)
010361	70mm ² (10m)	(1 pc)



Attacchi - Sockets - Connecteurs

(a) 010340	16mmq	(2 pcs)
(b) 010385	25mmq	(2 pcs)
(b) 010386	50mmq	(2 pcs)
(b) 010387	70mmq	(2 pcs)



Posizionatore magnetico
Magnetic position holder
Support magnétique

(a) 010345	MPH 62	(1 pc)
(b) 010346	MPH 92	(1 pc)

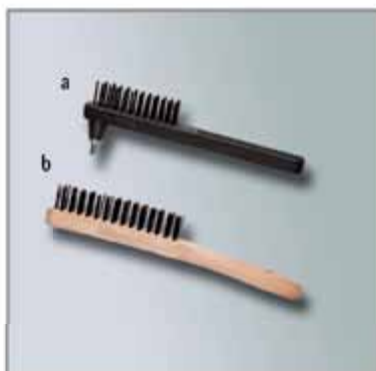

Spazzola - Brush - Brosse

(a) 010342	(1 pc)
(b) 010343	(1 pc)



Martellina battiscoria - Hammer
Marteau à piquer

010341	(1 pc)
--------	--------

Il giusto accessorio per ogni macchina The right accessory for each equipment Le droit accessoire pour chaque équipement



Modello Model Modèle	Kit di saldatura TIG - TIG Welding Kit - Kit soudage TIG			Torcia Torch Torche	Riduttore pressione Pressure reducer Manodétendeur	Adattatore Argon Argon adapter Adaptateur Argon	Cavo + Morsetto Massa Cable + Earth Clamp Cable + Pince de Masse	Tubo gas Gas Hose Tuyau de gaz
	A	A	A					
SIL 415	-	✓	-	010614	(c) 010242	010571	010258	-
SIL 417	-	✓	-	010614	(c) 010242	010571	010258	-
Mos GEN Series	✓	-	-	010611	(c) 010242	010571	010258	-
Mos EVO Series	✓	-	-	010611	(c) 010242	010571	010258	-
Mastro EVO Series	✓	-	-	010611	(c) 010242	010571	010258	-
Mastro HD Series	-	-	✓	010622	(c) 010242	010571	010314	-
Mastro 627	-	-	-	010230	(d) 010513	010571	010314	000216
E-Arc 840	-	-	-	010230	(d) 010513	010571	010316	000216
E-Arc 860	-	-	-	010230	(d) 010513	010571	010316	000216
SILTIG 415	-	-	-	010614	(c) 010242	010571	010258	-
Mastrotig 200	-	-	-	010232	(e) 010512	010571	010258	000216
Mastrotig 218 AC	-	-	-	010232	(e) 010512	010571	010173	000216
Mastrotig 216 AC/DC	-	-	-	010232	(e) 010512	010571	010173	000216
Mastrotig 327 AC/DC	-	-	-	010230	(e) 010512	010571	010314	000216
Mastrotig 327 AC/DC	-	-	-	010885				
Mastrotig 327 AC/DC	-	-	-	010887				
Decatig 200E	-	-	-	010230	(e) 010512	010571	010314	000216

110A Valve

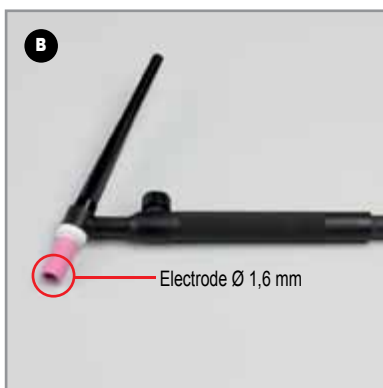

010614
Tig Torch 110A Eco Valve
3 m 25 mm²

010611
Tig Torch 110A Valve
4 m 25 mm²

010622
Tig Torch 110A Valve
4 m 50 mm²



Cappuccio lungo - Long cap
Capuchon long

(a) **010655** (3 pc)

Diffusore - Diffuser - Diffuseur

(b) Ø 1,6 **010657** (3 pcs)

Pinze serra elettrodo - Electrode holder

Pince porte électrode

(c) Ø 1,6 **010658** (3 pcs)

Ugello - Nozzle - Buse

(d) No.6 **010656** (10 pcs)

140A - 180A - 320A

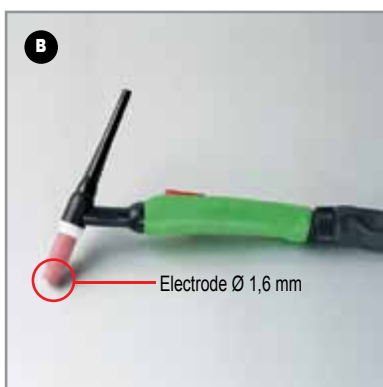

010232
Tig Torch 140A
4 m

010230
Tig Torch 180A
4 m

010885
Tig Torch 320A
4 m H₂O

010887
Tig Torch 320A
3 m H₂O

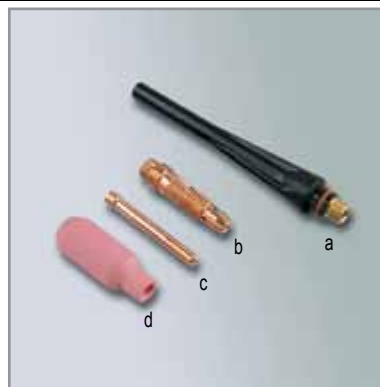

Cappuccio lungo - Long cap
Capuchon long

(a) **010369** (3 pc)

Diffusore - Diffuser - Diffuseur

(b) Ø 1,6 **010645** (3 pcs)

(b) Ø 2,4 **010643** (3 pcs)

(b) Ø 3,2 **010644** (3 pcs)

(b) Ø 4,0 **010660** (3 pcs)

Pinze serra elettrodo - Electrode holder

Pince porte électrode

(c) Ø 1,6 **010633** (3 pcs)

(c) Ø 2,4 **010635** (3 pcs)

(c) Ø 3,2 **010636** (3 pcs)

(c) Ø 4,0 **010661** (3 pcs)



Ugello - Nozzle - Buse

(d) No.6 **010690** (10 pcs)

(d) No.8 **010691** (10 pcs)

(d) No.10 **010692** (10 pcs)



Codice Code Référence	Diametro Diameter Diamètre	Quantità Quantity Quantité	Torcia Torch Torche	Intensità corrente Current intensity Intensité du courant	Gas di protezione Shielding gas Gaz de protection	Metalli saldabili Weldable Metals Métals soudable	Tipo di corrente Type of current Nature du courant
Elettrodo tungsteno/ce 2% Th/ce 2% tungsten electrode Electrode tungstène/ce 2%					Argon	Acciai ed Inox Steel and Stainless Acier et inox	
010694	ø 1,6	10 pcs	110A, 140A, 180A, 320A	10 - 80 Amp			
010696	ø 2,4	10 pcs	140A, 180A, 320A	90 - 120 Amp			
010668	ø 3,2	10 pcs	140A, 180A, 320A	125 - 240 Amp			
010663	ø 4,0	10 pcs	180A, 320A	125 - 240 Amp			
Elettrodo tungsteno puro Pure tungsten electrode Electrode tungstène					Argon	Leghe Leggere Light Alloys Alliages légers	
010697	ø 1,6	10 pcs	110A, 140A, 180A, 320A	40 - 80 Amp			
010699	ø 2,4	10 pcs	140A, 180A, 320A	70 - 120 Amp			
010700	ø 3,2	10 pcs	140A, 180A, 320A	125 - 240 Amp			
010662	ø 4,0	10 pcs	180A, 320A	125 - 240 Amp			

KIT TIG



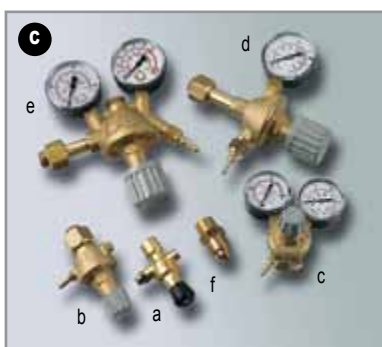

- 000197 **TG 9** (Torch 010611)
 000195 **TG 925** (Torch 010614)
 000190 **TG 950** (Torch 010622)

Electrode Ø 1,6 mm



**Riduttore di pressione - Pressure reducer -
Mano détendeur**

- (a) 010515 CO₂ (1 pc) 
 (b) 010499 CO₂ (1 pc) 
 (c) 010242 CO₂ (1 pc)
 (d) 010513 CO₂ (1 pc)
 (e) 010512 CO₂ (1 pc)
 (f) 010571 CO₂ → Ar (1 pc)







**Adattatore bombole ricaricabili/non ricaricabili
Adapter for refillable bottle/non refillable bottle
Adaptateur pour bouteilles rechargeables/non rechargeables**

- 010810 (1 pc)



**Cavo con morsetto di massa
Cable with earth clamp
Câble avec pince de masse**

- 010258 200A cavo 10 mm² (2m)  25 mm² (1 pc)
 010173 200A cavo 16 mm² (2,7m)  25 mm² (1 pc)
 010314 350A cavo 35 mm² (3m)  50 mm² (1 pc)
 010316 500A cavo 70 mm² (3m)  70 mm² (1 pc)



Tubo gas - Gas Hose - Tuyau de gaz

- 000216 1,5m (1 pc)



**Bombole non ricaricabili
Non refillable bottles
Bouteilles non rechargeables**

- 010503 Argon lt. 1 (1 pc)

Accessori Accessories Accessoires		Macchine Equipments EQUIPEMENTS	Starflux 130 Decastar 130	Startwin 135 EVO Startwin 165/1 EVO Startwin 180 E Decastar 135 EVO	Decastar 150 Decastar 180	D-mig 400 Series	D-mig 500 Series	D-mig 530 TDK	D-mig 532 TDKe Decamig 2500	D-mig 635 D-mig 735	D-mig 650 - 660 D-mig 750 - 760	D-mig 700 Series H ₂ O
A Torcia - Torch - Torche												
010464	140A 2m	140 Amp @ 60%	✓	-	-	-	-	-	-	-	-	-
010468	140A Valve 2m	140 Amp @ 60%	-	✓	-	-	-	-	-	-	-	-
010470	160A 2m	160 Amp @ 60%	-	-	✓	-	-	-	-	-	-	-
010234	180A 3m Euro	180 Amp @ 60%	-	-	-	✓	✓	✓	✓	-	-	-
010235	180A 4m Euro	180 Amp @ 60%	-	-	-	-	✓	✓	✓	-	-	-
010236	230A 3m Euro	230 Amp @ 60%	-	-	-	-	-	-	-	✓	-	-
010237	230A 4m Euro	230 Amp @ 60%	-	-	-	-	-	-	-	✓	-	-
010463	340A 3m Euro	340 Amp @ 60%	-	-	-	-	-	-	-	-	✓	-
010239	340A 4m Euro	340 Amp @ 60%	-	-	-	-	-	-	-	-	✓	-
010461	500A H ₂ O 3m Euro	500 Amp @ 100%	-	-	-	-	-	-	-	-	-	✓
010462	500A H ₂ O 4m Euro	500 Amp @ 100%	-	-	-	-	-	-	-	-	-	✓
010309	POT1 3m Euro	180 Amp @ 60%	-	-	-	-	-	-	✓	-	-	-
010271	POT2 3m Euro	180 Amp @ 60%	-	-	-	-	-	✓	-	-	-	-
010308	SPOOL GUN1 6m Euro	180 Amp @ 60%	-	-	-	-	-	-	✓	-	-	-
010270	SPOOL GUN2 6m "DINSE"	180 Amp @ 60%	-	-	-	-	-	✓	-	-	-	-
B Rullino trainafile - Wire guide roller - Galet d'entraînement												
010841	KIT: Fe \varnothing 0,6/0,8/1,0 Flux \varnothing 0,8/0,9/1,2 Al \varnothing 0,8/1,0	Blister 3 pcs	-	✓	✓	✓	-	-	-	-	-	-
010776	Fe \varnothing 0,6		-	✓	✓	✓	-	-	-	-	-	-
010673	Fe \varnothing 0,8 / 1,0 (Al \varnothing 0,8 / 1,0)		-	✓	✓	✓	-	-	-	-	-	-
010647	Fe \varnothing 0,6 / 0,8		-	-	-	-	✓	✓	✓	-	-	-
010628	Fe \varnothing 1,0 / 1,2		-	-	-	-	✓	✓	✓	-	-	-
011206	Fe \varnothing 0,6 / 0,8	(2 pcs)	-	-	-	-	-	-	-	✓	✓	✓
011207	Fe \varnothing 1,0 / 1,2	(2 pcs)	-	-	-	-	-	-	-	✓	✓	✓
010775	Flux \varnothing 0,8 / 0,9 / 1,2		✓	✓	✓	-	-	-	-	-	-	-
010627	Flux \varnothing 0,9		-	-	-	-	✓	✓	✓	-	-	-
011210	Flux \varnothing 1,2 / 1,6	(2 pcs)	-	-	-	-	-	-	-	✓	✓	✓
010673	Al \varnothing 0,8 / 1,0 (Fe \varnothing 0,8 / 1,0)		-	✓	✓	✓	-	-	-	-	-	-
010629	Al \varnothing 0,8 / 1,0		-	-	-	-	✓	✓	✓	-	-	-
011208	Al \varnothing 0,8 / 1,0	(2 pcs)	-	-	-	-	-	-	-	✓	✓	✓
011209	Al \varnothing 1,2 / 1,6	(2 pcs)	-	-	-	-	-	-	-	✓	✓	✓
011198	Fe \varnothing 0,6 / 0,8 SPOOL GUN		-	-	-	-	-	-	-	-	-	-
011199	Al \varnothing 0,8 / 1,0 SPOOL GUN		-	-	-	-	-	-	-	-	-	-
C Guaina guidafile - Liner - Guaine pour fil												
010241	Fe, Flux \varnothing 0,6 / 1,0	3m	✓	✓	✓	-	-	-	-	-	-	-
010743	Fe \varnothing 0,6 / 0,9	4m	-	-	-	✓	✓	✓	✓	✓	✓	✓
010744	Fe \varnothing 1,0 / 1,2	4m	-	-	-	✓	✓	✓	✓	✓	✓	✓
010745	Fe \varnothing 1,2 / 1,6	4m	-	-	-	-	-	-	-	✓	✓	✓
010370	Al \varnothing 0,8 / 1,0	3m	-	✓	✓	-	-	-	-	-	-	-
010746	Al \varnothing 0,8 / 1,0 / 1,2	3m	-	-	-	✓	✓	✓	✓	✓	✓	✓
010747	Al \varnothing 1,2 / 1,6	3m	-	-	-	-	-	-	-	✓	✓	✓
010384	Al \varnothing 1,0 / 1,2 Grafite	4m	-	-	-	✓	✓	✓	✓	✓	✓	✓



010464 MIG Torch 140A 2m (1 pc)
 010468 MIG Torch 140A VALVE 2m (1 pc)
 010470 MIG Torch 160A 2m (1 pc)



010234 MIG Torch 180A 3m EURO (1 pc)
 010235 MIG Torch 180A 4m EURO (1 pc)



010236 MIG Torch 230A 3m EURO (1 pc)
 010237 MIG Torch 230A 4m EURO (1 pc)



010463 MIG Torch 340A 3m EURO (1 pc)
 010239 MIG Torch 340A 4m EURO (1 pc)

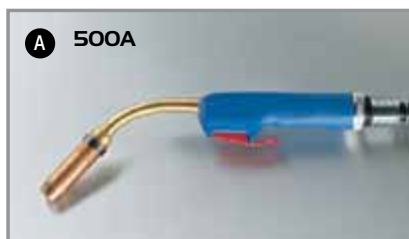

010461 MIG Torch 500A H2O 3m EURO (1 pc)
 010462 MIG Torch 500A H2O 4m EURO (1 pc)



Rullino trainafilo - Wire guide roller
 Galet d'entraînement



Torcia con regolazione della velocità del filo sull'impugnatura: ti facilita il controllo della saldatura.
Torch with wire speed adjustment on the gun: facilitates welding control.
Torche avec réglage de la vitesse du fil sur la poignée: facilite le contrôle du soudage.

010309
 MIG Torch POT 1 3m EURO (1 pc)
 010271
 MIG Torch POT 2 3m DINSE (1 pc)



Torcia Spool Gun
 Ha una bobina di filo continuo alloggiata nell'impugnatura: è ideale per l'utilizzo di fili morbidi (alluminio) senza problemi di trascinamento (regolazione della velocità del filo sull'impugnatura).
Torch Spool Gun
 With a continuous wire spool housed in the handle ideal for use with soft wire (aluminium) with no drawing problems (wire speed adjustment on the gun).
Torche Spool Gun
 Une bobine de fil continu se trouve sur la poignée: idéale pour l'utilisation de fils souples (aluminium) sans problème d'entraînement (réglage de la vitesse du fil sur la poignée).

010308
 MIG Torch SPOOL GUN 1 6m EURO (1 pc)





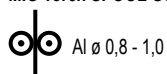



010270
 MIG Torch SPOOL GUN 2 6m DINSE (1 pc)



Rullino trainafilo
Wire guide roller
Galet d'entraînement
 011198 Fe ø 0,6 - 0,8 (1 pc)
 011199 Al ø 0,8 - 1,0 (1 pc)



Guaina guidafile - Liner - Guaine pour fil

Accessori Accessories Accessoires			Torce Torches		140 A (010464)	140A Valve (010468)	160A (010470)	180A 3m Euro (010234) 180A 4m Euro (010235) POT1 3m Euro (010309) POT2 3m Euro (010271)	SPOOL GUN1 6m Euro (010308) SPOOL GUN2 6m Euro (010270)	230A 3m Euro (010236) 230A 4m Euro (010237)	340A 3m Euro (010463) 340A 4m Euro (010239)	500A H2O 3m Euro (010461) 500A H2O 4m Euro (010462)
A Lancia - Lance												
010240		(1 pc)	✓	✓	-	-	-	-	-	-	-	-
010485		(1 pc)	-	-	✓	-	-	-	-	-	-	-
010484		(1 pc)	-	-	-	-	-	✓	-	-	-	-
010488		(1 pc)	-	-	-	-	✓	-	-	-	-	-
010489		(1 pc)	-	-	-	-	-	-	✓	-	-	-
010490		(1 pc)	-	-	-	-	-	-	-	✓	-	-
010492		(1 pc)	-	-	-	-	-	-	-	-	-	✓
B Molla - Spring - Ressort												
010437		(10 pcs)	✓	✓	✓	✓	✓	✓	-	-	-	-
010436		(10 pcs)	-	-	-	-	-	-	✓	-	-	-
C Portapunta - Collet body nozzle - Support buse												
010439		(20 pcs)	-	-	-	-	-	-	-	-	✓	-
010405		(10 pcs)	-	-	-	-	-	-	-	-	-	✓
D Diffusore gas - Gas diffuser - Gas diffuseur												
010997		(10 pcs)	-	-	-	-	-	-	-	✓	-	-
010998		(10 pcs)	-	-	-	-	-	-	-	-	✓	-
010999		(10 pcs)	-	-	-	-	-	-	-	-	-	✓
E Ugello portacorrente Acciaio - Contact tip Steel - Buse Acier												
010448	(a) Fe M6 Ld	ø 0,6 (20 pcs)	-	✓	✓	✓	✓	✓	✓	✓	✓	-
010253	(a) Fe M6 Ld	ø 0,6 (3 pcs) 	-	✓	✓	✓	✓	✓	✓	✓	✓	-
010449	(a) Fe M6 Ld	ø 0,8 (20 pcs)	-	✓	✓	✓	✓	✓	✓	✓	✓	-
010254	(a) Fe M6 Ld	ø 0,8 (3 pcs) 	-	✓	✓	✓	✓	✓	✓	✓	✓	-
010450	(a) Fe M6 Ld	ø 1,0 (20 pcs)	✓	✓	✓	✓	✓	✓	✓	✓	✓	-
010255	(a) Fe M6 Ld	ø 1,0 (3 pcs) 	✓	✓	✓	✓	✓	✓	✓	✓	✓	-
010451	(a) Fe M6 Ld	ø 1,2 (20 pcs)	-	-	-	-	-	-	-	✓	✓	-
010942	(b) Fe M6 Hd	ø 1,0 (20 pcs)	-	-	-	-	-	-	-	✓	✓	-
010943	(b) Fe M6 Hd	ø 1,2 (20 pcs)	-	-	-	-	-	-	-	✓	✓	-
010944	(b) Fe M6 Hd	ø 1,6 (20 pcs)	-	-	-	-	-	-	-	-	✓	-
010945	(c) Fe M8	ø 0,8 (20 pcs)	-	-	-	-	-	-	-	-	-	✓
010946	(c) Fe M8	ø 1,0 (20 pcs)	-	-	-	-	-	-	-	-	-	✓
010947	(c) Fe M8	ø 1,2 (20 pcs)	-	-	-	-	-	-	-	-	-	✓
010948	(c) Fe M8	ø 1,6 (20 pcs)	-	-	-	-	-	-	-	-	-	✓
E Ugello portacorrente Alluminio - Contact tip Aluminum - Buse Aluminio												
010949	(a) Al M6	ø 0,8 (20 pcs)	-	✓	✓	✓	✓	✓	✓	✓	✓	-
010256	(a) Al M6	ø 0,8 (3 pcs) 	-	✓	✓	✓	✓	✓	✓	✓	✓	-
010992	(a) Al M6	ø 1,0 (20 pcs)	-	✓	✓	✓	✓	✓	✓	✓	✓	-
010257	(a) Al M6	ø 1,0 (3 pcs) 	-	✓	✓	✓	✓	✓	✓	✓	✓	-
010993	(a) Al M6	ø 1,2 (20 pcs)	-	-	-	-	-	-	-	✓	✓	-
010994	(c) Al M8	ø 1,0 (20 pcs)	-	-	-	-	-	-	-	-	-	✓
010995	(c) Al M8	ø 1,2 (20 pcs)	-	-	-	-	-	-	-	-	-	✓
010996	(c) Al M8	ø 1,6 (20 pcs)	-	-	-	-	-	-	-	-	-	✓
F Ugello gas - Gas nozzle - Buse à gas												
010443		ø 12 (5 pcs)	✓	✓	✓	✓	✓	✓	-	-	-	-
010252		ø 12 (2 pcs) 	✓	✓	✓	✓	✓	✓	-	-	-	-
010444		ø 15 (5 pcs)	-	-	-	-	-	-	✓	-	-	-
010445		ø 16 (5 pcs)	-	-	-	-	-	-	-	✓	-	-
010406		ø 20 (10 pcs)	-	-	-	-	-	-	-	-	-	✓



Lancia - Lance



Molla - Spring - Ressort



Portapunta - Collet body nozzle - Support buse



Diffusore gas - Gas diffuser - Gas diffuseur





Ugello portacorrente - Contact tip - Buse



Ugello gas - Gas nozzle - Buse à gas



Riduttore di pressione - Pressure reducer -
Mano détenteur

- | | | | |
|------------|----------------------|--------|---|
| (a) 010515 | CO ₂ | (1 pc) |  |
| (b) 010499 | CO ₂ | (1 pc) |  |
| (c) 010242 | CO ₂ | (1 pc) | |
| (d) 010513 | CO ₂ | (1 pc) | |
| (e) 010512 | CO ₂ | (1 pc) | |
| (f) 010571 | CO ₂ → Ar | (1 pc) | |



Adattatore bombole ricaricabili/non ricaricabili
Adapter for refillable bottle/non refillable bottle
Adaptateur pour bouteilles rechargeables/non rechargeables

010810 (1 pc) 



Tubo gas - Gas Hose - Tuyau de gaz

000216 1,5m (1 pc)



Bombole non ricaricabili
Non refillable bottles
Bouteilles non rechargeables

- | | | | |
|--------|------------------------|-------|--------|
| 010501 | Argon | lt. 1 | (1 pc) |
| 010502 | Argon/ CO ₂ | lt. 1 | (1 pc) |
| 010503 | CO ₂ | lt. 1 | (1 pc) |



Anti Stick spray

010621 (1 pc)

Codice Code Référence		Startwin 135 EVO Startwin 165/1 EVO Decastar 135 EVO	Startwin 180E Decastar 150E Decastar 180E	D-mig 420 S D-mig 420 T	D-mig 520 T D-mig 525 T D-mig 520 SD D-mig 525 TD D-mig 530 SD Decamig 2500 D-mig 530 TDK D-mig 532 TDKe	D-mig 635 TD D-mig 650 TD D-mig 660 TD	D-mig 735 TD D-mig 750 TD D-mig 760 TD
1 010397	Kit GAS	✓	✓	✓	-	-	-
2 010410	Kit GAS	✓	✓	✓	-	-	-
3 010415	Kit Fe	✓	✓	✓	-	-	-
4 010394	Kit Fe	✓	✓	✓	-	-	-
5 010413	Kit Al	✓	✓	-	-	-	-
6 010420	Kit Al	-	-	✓	-	-	-
7 010418	Kit Al	-	-	-	✓	-	-
8 010411	Kit Al	-	-	-	-	✓	✓

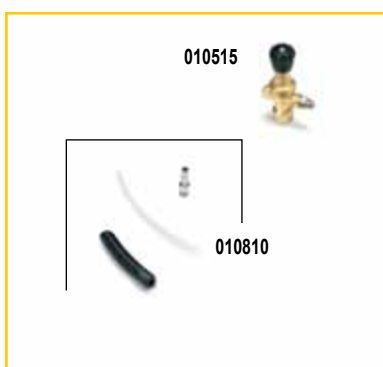

1 010397
Kit Bombole non ricaricabili
Kit non refillable bottles
Kit Bouteilles non rechargeables



2 010410
Kit Bombole non ricaricabili
Kit non refillable bottles
Kit Bouteilles non rechargeables

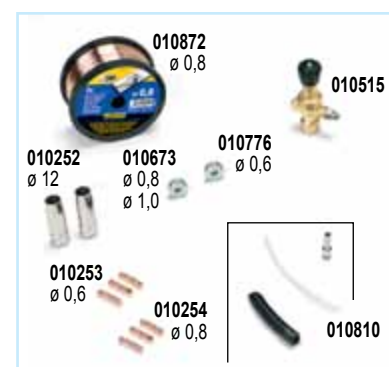

3 010415
Kit filo Acciaio & bombole non ricaricabili
Kit Steel wire & non refillable bottles
Kit fil acier & bouteilles non rechargeables



4 010394
Kit filo Acciaio & bombole ricaricabili
Kit Steel wire & refillable bottles
Kit fil acier & bouteilles rechargeables



5 010413
Kit filo alluminio - Kit aluminum wire
Kit fil aluminium



6 010420
Kit filo alluminio - Kit aluminum wire
Kit fil aluminium



7 010418
Kit filo alluminio - Kit aluminum wire
Kit fil aluminium

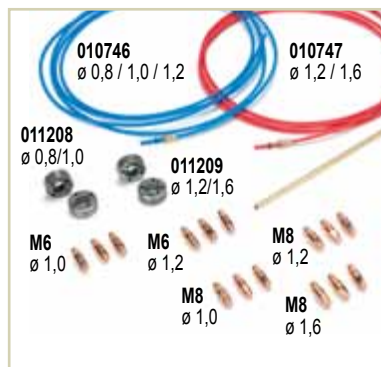

8 010411
Kit filo alluminio - Kit aluminum wire
Kit fil aluminium

Il giusto accessorio per ogni macchina The right accessory for each equipment Le droit accessoire pour chaque équipement



Torce PAC - PAC Torches - PAC Torches

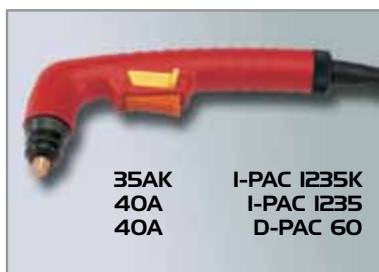

010351 PAC Torch 35AK 4m (1 pc)
010334 PAC Torch 40A 4m (1 pc)
010228 PAC Torch 40A 6m (1 pc)



010393 PAC Torch 80A 6m (1 pc)



010909 PAC Torch 100A 6m (1 pc)

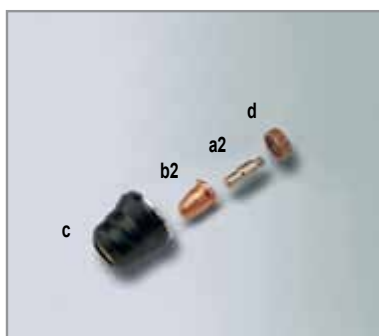

PAC Torch 35AK (I-PAC 1235K)

(d) **010179** (2 pcs)
(a2) **010180** (10 pcs)
(b2) Ø 0,6 mm. **010961** (10 pcs)
(b2) Ø 0,8 mm. **010183** (10 pcs)
(c) **010198** (4 pcs)

PAC Torch 40A (I-PAC 1235)

(d) **010179** (2 pcs)
(a2) **010180** (10 pcs)
(b2) Ø 0,6 mm. **010961** (10 pcs)
(b2) Ø 0,8 mm. **010183** (10 pcs)
(c) **010186** (4 pcs)

PAC Torch 40A (D-PAC 60)

(d) **010179** (2 pcs)
(a2) **010180** (10 pcs)
(b2) Ø 0,8 mm. (30A) **010183** (10 pcs)
(b2) Ø 0,9 mm. (50A) **010123** (10 pcs)
(c) **010186** (4 pcs)

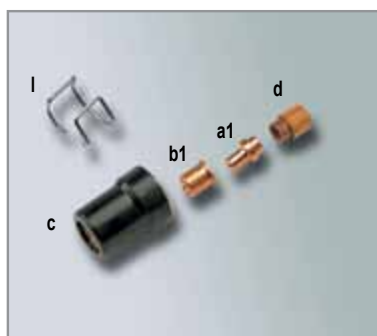

PAC Torch 80A (D-PAC 90)

(d) **010117** (2 pcs)
(a1) **010116** (10 pcs)
(b1) Ø 1,0 mm. (50A) **010118** (10 pcs)
(b1) Ø 1,2 mm. (80A) **010119** (10 pcs)
(c) **010120** (2 pcs)
(l) **010121** (10 pcs)



PAC Torch 100A (D-PAC 120)

(a) **010435** (10 pcs)
(b) ø 1,1 (60A) **010122** (10 pcs)
(b) ø 1,4 (100A) **010434** (10 pcs)
(b) ø 1,7 (130A) **010433** (10 pcs)
(b) ø 3,0 (gouging) **010432** (10 pcs)
(c) **010431** (2 pc)
(e) **010429** (2 pc)
(l) **010425** (10 pcs)
(i) **010680** (2 pcs)
(f) **010427** (10 pcs)
(g) **010683** (2 pcs)
(d) **010684** (2 pcs)
(h) **010685** (1 pc)

- (a) Elettrodo
- (b) Ugello
- (c) Porta ugello
- (d) Diffusore aria
- (e) Portaugello per taglio a contatto
- (f) Distanziale taglio a contatto
- (g) Distanziale per scriccatura
- (h) Carrello per taglio
- (i) Distanziale a 2 punte
- (l) Molla distanziale

- (a) Electrode
- (b) Nozzle
- (c) Nozzle holder
- (d) Swirl
- (e) Bearing cutting nozzle holder
- (f) Spacer for bearing cutting
- (g) Gouging spacer
- (h) Wheeled spacer
- (i) Spacing bush with 2 feet
- (l) Spacing ring

- (a) Electrode
- (b) Buse
- (c) Support buse
- (d) Diffuseur
- (e) Support buse pour coupe à appui
- (f) Entretoise pour coupe à appui
- (g) Entretoise pour gougeage
- (h) Entretoise avec roues
- (i) Entretoise à 2 pointes
- (l) Ressort d'espacement

Glossario Saldatura

Alimentazione monofase

ciruito elettrico al quale è possibile collegare solo apparecchi monofase (2 fili + terra o solo 2 fili). E' la tensione normalmente disponibile nelle case.

Alimentazione trifase

ciruito elettrico al quale è possibile collegare solo apparecchi trifase (3 fili + terra). E' la tensione normalmente disponibile nelle utenze professionali.

Arco di saldatura

è la distanza, fra la punta dell'elettrodo ed il pezzo da saldare, nella quale scorre la corrente che crea il calore necessario alla fusione.

Campo di regolazione

quantità di corrente di saldatura minima e massima che l'impianto può erogare.

Corrente alternata AC

corrente elettrica che cambia la sua direzione ad intervalli regolari definiti dal numero dei cicli 50/60 Hertz. In corrente alternata si possono saldare elettrodi a rivestimento rutile e con il procedimento TIG le leghe di alluminio e magnesio.

Corrente continua DC

corrente elettrica che scorre in un senso senza cambiare la direzione come nella corrente alternata. In corrente continua si può saldare ad elettrodo e TIG acciaio, inox, titanio, rame, bronzo, nickel, ottone.

Elettrodi utilizzabili

diametro minimo e massimo degli elettrodi rivestiti che l'impianto può utilizzare. Sono funzione del campo di regolazione.

Fusibile di rete

indica il valore, in ampere, del dispositivo che deve interrompere l'alimentazione in caso di eccessivo assorbimento di energia.

MIG MAG

è il processo di saldatura che utilizza un arco elettrico ed un filo in bobina come materiale d'apporto. Durante la saldatura il metallo del filo e quello del pezzo da saldare si fondono insieme, formando un bagno fuso che raffreddandosi diventa il cordone di saldatura. Il filo è spinto attraverso la torcia da un sistema di trascinamento motorizzato. A differenza dell'elettrodo rivestito non serve sostituire in continuazione l'elettrodo e non si ha la formazione di scoria da rimuovere. La protezione del bagno di saldatura è assicurata da un gas che fluisce attraverso l'ugello della torcia creando uno schermo fra il bagno di saldatura e l'atmosfera. Il sistema è detto MIG o MAG a seconda del tipo di gas utilizzato: Argon = MIG; CO₂ o miscela Argon/CO₂ = MAG.

MMA

è il processo di saldatura che utilizza un arco elettrico che si forma fra un elettrodo rivestito ed il pezzo da saldare. Durante la saldatura il metallo dell'elettrodo e del pezzo da saldare si fondono insieme formando un bagno fuso che, raffreddandosi, diventa il cordone di saldatura. Il rivestimento esterno dell'elettrodo serve a creare, vaporizzandosi, un'atmosfera gassosa che protegge il bagno di saldatura dall'aria esterna. Forma inoltre una scoria, a protezione del cordone di saldatura, che sarà rimossa una volta raffreddata.

NO GAS (filo animato)

è un processo simile a quello MIG MAG ma non utilizza un gas a protezione del bagno di saldatura. Utilizza uno speciale filo animato che contiene al suo interno una sostanza simile, per comportamento, al rivestimento esterno degli elettrodi che, vaporizzandosi, crea un gas a protezione del bagno di saldatura dall'atmosfera.

PLASMA

è il processo di taglio che utilizza un arco elettrico ed aria compressa. L'arco elettrico passa dall'elettrodo, contenuto nella torcia, al pezzo di metallo da tagliare attraverso un piccolo foro dove scorre contemporaneamente anche l'aria compressa, erogata da un compressore esterno. L'aria, portata dall'arco elettrico ad una temperatura elevatissima, taglia il metallo.

Posizioni di saldatura

numero di regolazioni della potenza di saldatura negli impianti MIG MAG. Si seleziona in base allo spessore da saldare.

Potenza d'installazione KW (Kilowatt)

indica quanta potenza deve avere l'impianto elettrico per poter utilizzare la saldatrice.

Protezione termostatica

interrompe la corrente di saldatura quando viene superato il servizio di saldatura (numero elettrodi/ora) e la ripristina automaticamente quando la temperatura è ritornata nella norma.

Regolazione continua della corrente di saldatura

la regolazione è fatta in maniera molto precisa, con variazioni minime, per adattarsi perfettamente alle varie esigenze di saldatura.

Servizio

numero di minuti che una saldatrice può operare ad un determinato amperaggio senza che si surriscaldi od intervenga il dispositivo di protezione termica. Per esempio 200 Amp a 60% di servizio significa che la saldatrice può essere usata a cicli di sei minuti di lavoro e quattro minuti di raffreddamento.

SPOT Saldatura a resistenza

è il processo di saldatura che utilizza il calore prodotto dalla corrente elettrica che passa nel punto dove le superfici dei particolari da saldare vengono serrati dalla pinza puntatrice. Il calore necessario per la saldatura è prodotto dalla resistenza generata dal metallo al passaggio della corrente e non dall'arco elettrico.

SPOT Saldatura a studder

la saldatura a studder sfrutta il principio della saldatura a resistenza utilizzando una speciale pistola porta-elettrodo.

Tensione a vuoto

è la tensione, misurata in Volt, presente ai cavi terminali dell'impianto. Tale tensione è necessaria per avere immediatamente la corrente di saldatura non appena si chiude il circuito elettrodo pezzo da saldare.

TIG

è il processo di saldatura che utilizza un elettrodo di tungsteno, contenuto nella torcia, per creare l'arco elettrico con il pezzo da saldare. L'elettrodo di tungsteno, metallo con un altissimo punto di fusione (3410°), non si consuma e non si fonde nel bagno di saldatura. Se occorresse materiale d'apporto, l'operatore utilizzerà delle barrette di materiale compatibile a quello da saldare fondendole nel cordone di saldatura. La protezione del bagno di saldatura è assicurata da un gas protettivo che fluisce dall'ugello della torcia.

Welding Glossary

Alternating current AC

electrical current that reverses its direction at regular intervals, established by the cycles number 50/60 Hertz. When using alternating current you can weld rutile electrodes and with the TIG process, aluminium and magnesium alloys. Continuous adjustment of welding current: This adjustment is extremely precise, with minimum changes to perfectly meet all several welding requirements.

Direct current DC

electrical current that flows in one direction only, without reversing its course, unlike the alternating current. When using direct current you can perform electrode and TIG welding on steel, stainless steel, titanium, copper, bronze, nickel, brass.

Duty cycle

the number of minutes an equipment can operate at a specific amperage, without overheating or triggering the overload protection device. For example, 200 Amp at 60% duty cycle means that the welder can be used in cycles of six minutes working time and four minutes cooling time.

Fuse

indicates the value, in amperes, of the device used to cut-off the power supply in case of excessive power absorption.

Installation power KW (Kilowatt)

indicates the electric mains output power to use a welding equipment.

MIG MAG

this is a welding process using an electric arc and a spool wire as weld material. While welding the wire and the workpiece are fused together forming a molten puddle which, on cooling, becomes the line of welding. A motor drive system feeds the wire through the torch. Unlike coated electrodes, you don't need to replace the electrode each time and no slag is formed. The welding puddle is protected by a gas that flows through the torch's nozzle, creating a shield between the welding puddle and the atmosphere. The system is known as MIG or MAG, according to the type of gas used: MIG = Argon; MAG = CO₂ or Argon/CO₂ mixture.

MMA

this is a welding process using an electric arc and a spool wire as weld material. While welding the wire and the workpiece fuse together forming a molten puddle which, on cooling, becomes the line of welding. As the external electrode coating evaporates, it creates a gaseous atmosphere shielding the welding puddle from the outside air. It also protects the line of welding by forming a slag, which is removed when cold.

NO GAS (Self-shielded wire)

this is a process similar to the MIG MAG, but it doesn't use a gas to shield the welding puddle. A special self-shielded wire is used containing a substance similar to the electrodes external coating one and which, on evaporating, creates a gas protecting the welding puddle from the atmosphere.

Open circuit voltage

the voltage (Volt) of the equipment's terminal cables. This voltage is required to immediately obtain the welding current upon electrode workpiece circuit closing.

Overload protection

cuts off the welding current when the duty cycle limit (number of electrodes/time) has been exceeded and restores it automatically when the temperature has returned to normal.

PLASMA CUTTING

this is a cutting process using an electric arc and compressed air. The electric arc flows from the electrode, fitted in the torch, to the piece of metal being cut through a small hole in the torch together with compressed air, delivered by an external compressor. The air, which is brought up to an extremely high temperature by the electric arc, cuts the metal.

Single-phase power supply

electrical circuit to which it's possible to connect only single-phase appliances (2 wires + earth, or 2 wires only). It's the voltage usually available at home.

SPOT Resistance welding

this welding process uses the heat produced by the electric current flowing in the point where the surfaces of the parts to be welded are locked together by the spot welding gun. The heat required for welding is produced by the resistance generated by the metals to the passage of the current, rather than the electric arc.

SPOT Studder welding

studder welding takes advantage of the resistance welding principle using a special electrode-holder gun.

Three-phase power supply

electrical circuit to which it's possible to connect only three-phase appliances (3 wires + earth). It's the voltage usually available for professional uses.

TIG

this is the welding process using a tungsten electrode, fitted in the welding torch, to create the electrical arc with the workpiece. Being a metal with an extremely high melting point (3410°) the tungsten electrode is not consumed or melted in the welding puddle. If weld material is required, the operator will use bars compatible with the workpiece, melting them along the line of welding. Welding puddle shielding is provided by a protective gas flowing from the nozzle of the torch.

Usable electrodes

minimum and maximum coated electrodes diameter can be used by an equipment. They change according to the welding current range.

Welding arc

this is the space between the electrode's tip and the workpiece, in which the current flows creating the heat required for the fusion.

Welding current range

minimum and maximum output welding current quantity.

Welding positions

number of welding power adjustments in MIG MAG equipments. Selected according to the thickness to be welded.

Glossaire de Soudure

Alimentation monophasée

circuit électrique auquel il n'est possible de relier que des appareils monophasés (2 fils + terre ou seulement 2 fils). Cette tension est celle normalement disponible dans les habitations.

Alimentation triphasée

circuit électrique auquel il n'est possible de relier que des appareils triphasés (3 fils + terre). Cette tension est celle normalement disponible dans les utilisations professionnelles.

Arc de soudage

il s'agit de l'espace, entre la pointe de l'électrode et la pièce à souder, dans lequel passe le courant qui crée la chaleur nécessaire à la fusion.

Champ de réglage

quantité de courant de soudage minimum et maximum qu'un équipement peut distribuer.

Courant alternatif AC

courant électrique qui change de direction à intervalles réguliers définis par le nombre des cycles 50/60 Hertz. En courant alternatif, on peut souder des électrodes à enrobage rutile et, avec le procédé TIG, les alliages d'aluminium et de magnésium.

Courant continu DC

courant électrique qui passe dans un sens sans changer de direction comme dans le courant alternatif. En courant continu, on peut souder à l'électrode et avec procédé TIG l'acier, l'inox, le titane, le cuivre, le bronze, le nickel, le laiton.

Electrodes utilisables

diamètre minimum et maximum des électrodes enrobées qu'un équipement peut utiliser. Ils dépendent du champ de réglage.

Facteur de marche

nombre de minutes pendant lesquelles un poste peut souder, à une intensité de courant déterminée, sans surchauffer ou sans qu'intervienne le dispositif de protection thermostatique. Par exemple, 200 Amp à 60% de service signifie que le poste à souder peut être utilisé en cycles de six minutes de travail et quatre minutes de refroidissement.

Fusible

indique la valeur, en ampères, du dispositif qui doit interrompre l'alimentation en cas d'absorption excessive d'énergie.

MIG MAG

il s'agit du procédé de soudage qui utilise un arc électrique et un fil en bobine en tant que matériau d'apport. Pendant le soudage, le métal du fil et celui de la pièce à souder s'unissent en formant un bain de fusion qui, en se refroidissant, devient le cordon de soudure. Le fil est poussé à travers la torche par un système d'entraînement motorisé. Contrairement à l'électrode enrobée, il n'est pas nécessaire de remplacer continuellement l'électrode et l'on travaille en absence de laitiers à éliminer. La protection du bain de soudage est assurée par un gaz qui passe à travers la buse de la torche en créant un écran entre le bain de soudage et l'atmosphère. Le système est dénommé MIG ou MAG selon le type de gaz utilisé: MIG = Argon; MAG = CO₂ ou mélange Argon/CO₂.

MMA

ce procédé de soudage utilise un arc électrique qui se forme entre une électrode enrobée et la pièce à souder. Pendant le soudage, le métal de l'électrode et celui de la pièce à souder s'unissent en formant un bain de fusion qui, en se refroidissant, devient le cordon de soudure. Le revêtement extérieur de l'électrode sert à créer, en s'évaporant, une atmosphère gazeuse qui protège le bain de soudage de l'air extérieur. En outre, il crée un laitier, à protection du cordon de soudure, qui sera éliminé après le refroidissement.

NO GAS (Fil fourré)

ce procédé est similaire à celui MIG MAG mais il n'utilise pas de gaz en protection du bain de soudage. Il utilise un fil spécial fourré en bobine qui contient une substance similaire, par comportement, au revêtement extérieur des électrodes qui, en s'évaporant, crée un gaz de protection du bain de soudage vis-à-vis de l'atmosphère.

PLASMA

il s'agit du procédé de coupe qui utilise un arc électrique et de l'air comprimé. L'arc électrique passe de l'électrode, contenue dans la torche, à la pièce de métal à couper à travers un petit trou ou glisse dans le même temps l'air comprimé distribué par un compresseur extérieur. L'air, amené par l'arc électrique à une température très élevée, coupe le métal.

Positions de soudure

nombre de réglages de la puissance de soudage dans les équipements MIG MAG. Il est sélectionné en fonction de l'épaisseur à souder.

Protection thermostatique

interrompt le courant de soudage lorsque le facteur de marche (nombre d'électrodes/heure) est dépassé et le rétablit automatiquement quand la température retourne à la normalité.

Puissance d'installation KW (Kilowatt)

indique la puissance nécessaire à l'installation électrique pour pouvoir utiliser un poste à souder.

Régulation continue du courant de soudage

le réglage est réalisé de façon très précise, avec des variations minimes, pour s'adapter parfaitement aux différentes exigences de soudage.

SPOT Soudage a resistance

il s'agit du procédé de soudage qui utilise la chaleur produite par le courant électrique qui passe sur le point où les surfaces des pièces à souder sont serrées par la pince de soudage. La chaleur nécessaire au soudage est produite par la résistance opposée par le métal au passage du courant et non pas par l'arc électrique.

SPOT Soudage a studder

le soudage à studder utilise le principe du soudage à résistance et emploie un pistolet porte-électrode spécial.

Tension a vide

il s'agit de la tension, mesurée en Volts, présente aux câbles d'extrémité de l'équipement. La tension est nécessaire pour avoir immédiatement le courant de soudage dès que le circuit électrode pièce à souder se ferme.

TIG

il s'agit du procédé de soudage qui utilise une électrode au tungstène, présente dans la torche, pour créer l'arc électrique avec la pièce à souder. L'électrode au tungstène a un point de fusion très élevé (3410°) et ne s'use pas ni ne fond dans le bain de soudage. Si le métal d'apport est nécessaire, l'opérateur utilise des barrettes de matériau compatible avec celui à souder, en les fondant dans le cordon de soudure. La protection du bain de soudage est assurée par un gaz protecteur qui passe par la buse de la torche.



la ventilazione forzata, raffreddando il generatore di corrente che si riscalda durante l'utilizzo, permette di saldare più a lungo.



the current power source, heating up during use, is cooled by a forced ventilation, allowing welding to continue for longer.



la ventilation forcée refroidit le générateur de courant qui chauffe pendant l'utilisation et elle permet donc de souder davantage.

Glossario Carica Batterie

Alimentazione: monofase

Circuito elettrico al quale è possibile collegare solo apparecchi monofase (2 fili + terra o solo 2 fili). È la tensione normalmente disponibile nelle case.

Alimentazione: trifase

Circuito elettrico al quale è possibile collegare solo apparecchi trifase (3 fili + terra). È la tensione normalmente disponibile nelle utenze professionali.

Capacità batteria (Ah)

Indica il valore della batteria più piccola e più grande che si consiglia di ricaricare con un dato carica batterie. La capacità nominale di riferimento è calcolata su un periodo di 15 ore, sufficiente per avere una ricarica ottimale (circa 80% della capacità). Gli Ampere/ora indicano quanta energia può accumulare la batteria.

Carica rapida

Serve a caricare una batteria in tempi ristretti. Questa funzione, utile in situazioni d'emergenza, ripristina rapidamente la potenza della batteria ma non permette una carica ottimale e, se utilizzata di frequente, riduce l'efficienza della batteria.

Corrente di avviamento: Amp 0 Volt CC - Amp 1 Volt / el

Indica, con due diversi metodi di misura, gli Ampere che un carica batterie con la funzione booster (avviamento rapido) eroga per pochi secondi e che, sommati a quelli erogati dalla batteria, permettono di avviare un motore.

0 Volt CC = Corrente di picco in avviamento

1 Volt / el = Corrente di carica convenzionale EN 60335-2-29 (1V/C)

Corrente di carica: media / efficace

Indica, con due diversi metodi di misura, la corrente che il carica batterie trasferisce alla batteria.

Limitazione di tensione

La tensione di carica della batteria è automaticamente limitata per evitare di sovraccaricare la batteria ed evitare l'evaporazione dell'elettrolito.

Posizioni di carica

Sono presenti in alcuni carica batterie e servono a regolare gli Ampere erogati.

Potenza

Indica quanta potenza deve avere l'utenza elettrica per poter alimentare il carica batterie.

Tensione nominale batteria

È la tensione della batteria che deve essere ricaricata. Ogni batteria è composta da più celle da 2 Volts ciascuna; le batterie più tipiche sono da 6, 12, 24 Volts

Tipo di batteria

Batteria al Ni-Cd

Utilizza componenti in Nickel Cadmio che assicurano una durata molto elevata. Per il costo elevato trova utilizzo solo in impieghi speciali (sistemi di allarme, sicurezza, etc.)

Batteria al piombo con elettrolito liquido

È utilizzata nel settore autotrazione. La batteria è costituita da più elementi in composti di piombo (celle), annegati in una soluzione di acqua ed acido solforico.

Batteria al piombo elettrolito Gel

Contiene acido solforico che assorbito da Silica forma una gelatina. Il vantaggio dato da questa soluzione è l'impossibilità di avere perdite di acido in caso di riballamenti o rotture. È importante non sovraccaricarla per evitare l'evaporazione dell'elettrolito.

Batteria al piombo sigillata "senza manutenzione"

Non può essere aperta per aggiungere l'elettrolito, quindi è importante non sovraccaricarla per evitare l'evaporazione del liquido. In realtà anche questa batteria ha dei fori per lo sfogo dei gas.

Batterie al piombo AGM

Contiene acido solforico assorbito da separatori in fibra di vetro. Il vantaggio dato da questa soluzione è l'impossibilità di avere perdite di acido in caso di riballamenti o rotture. È importante non sovraccaricarla per evitare l'evaporazione dell'elettrolito.

Batterie al piombo Ca-Ca

Nelle piastre positive e negative l'antimonio è sostituito da una lega di Calcio. L'evaporazione dell'elettrolito e l'autoscarica della batteria sono minori rispetto alle batterie con antimonio.

Batterie al piombo per trazione

Batterie per veicoli elettrici: carrelli elevatori, spazzatrici, ecc.

Battery Charger Glossary

Battery capacity (Ah)

Indicates the values for the smallest and largest batteries that can be recharged using a battery charger. The rated reference capacity is calculated over a period of 15 hours, which is sufficient to give an optimum recharge (approximately 80% of the capacity). The Amperes/hour indicate how much energy can be accumulated by the battery.

Boosting current: Amp 0 Volt CC - Amp 1 Volt / el

Indicates, with two different methods of measurement, the Amperes that a battery charger with booster function (Start-assist) provides for a few seconds and which, added to those provided by the battery, allows you to start an engine.

0 Volt CC = Starting peak current

1 Volt / el = Rated charge current EN 60335-2-29 (1V/C)

Charging current: Average / effective

Two different forms of measurement indicate the current being transferred to the battery by the battery charger.

Charging positions

These are found in certain battery chargers, and regulate the Amperes delivered.

Fast charging

Used to charge a battery in a short period of time. This function, useful in emergency situations, rapidly restores battery power but does not allow optimum charging and, if used frequently, reduces the efficiency of the battery itself.

Input voltage: single-phase

Electrical circuit to which it is possible to connect only single-phase appliances (2 wires + earth, or 2 wires only). This is the type of power supply normally available in the home.

Input voltage: Three-phase

Electrical circuit to which it is possible to connect only three-phase appliances (3 wires + earth). This is the type of power supply normally available for professional users.

Nominal battery voltage

This is the voltage of the battery to be recharged. Each battery is made up of a number of 2 Volt cells; the most common types of battery are 6, 12, 24 Volts.

Power

Indicates the power supply required to feed the battery charger.

Voltage limitation

The charging voltage is automatically limited in order to prevent overcharging and to prevent evaporation of the electrolyte.

Battery types

Ni-Cd battery

Uses Nickel-cadmium components for long life. Due to its high cost it is only used for special purposes (alarm systems, safety devices, etc.)

Pb/Wet battery

Used in the automotive sector. The battery comprises a number of elements made of lead compounds (cells), covered by a solution of water and sulphuric acid.

Pb/Gel lead battery

Contains sulphuric acid which forms a gel when absorbed by Silica. The advantage of this is that there is no risk of acid leaking in the event of overturning or breakage. Never overcharge the battery, to prevent evaporation of the electrolyte.

Maintenance free lead battery

Cannot be opened to add electrolyte, so the battery must never be overcharged, to avoid evaporation of the liquid. This type of battery also has gas outlet holes.

Pb/AGM lead battery

Contains sulphuric acid absorbed in a fiber glass mat separator. The advantage of this is that there is no risk of acid leaking in the event of overturning or breakage. Never overcharge the battery, to prevent evaporation of the electrolyte.

Pb/Ca-Ca lead battery

On both positive and negative plates the antimony is replaced by a calcium alloy. The electrolyte evaporation and the self-discharge are lower than that of antimony batteries.

Traction Pb lead battery

Batteries for electric vehicle: Forklifts, sweepers, etc.

Glossaire Chargeurs de Batteries

Alimentation: monophasée

Circuit électrique auquel il n'est possible de brancher que des appareils monophasés (2 fils + terre ou seulement 2 fils). Cette tension est celle normalement disponible dans les habitations

Alimentation: triphasée

Circuit électrique auquel il n'est possible de brancher que des appareils triphasés (3 fils + terre). Cette tension est celle normalement disponible dans les utilisations professionnelles.

Capacité batterie (Ah)

Indique la valeur de la batterie plus petite et de la batterie plus grande qu'il est conseillé de recharger avec un chargeur de batteries. La capacité nominale de référence est calculée sur une période de 15 heures, qui suffisent pour une recharge optimale (environ 80% de la capacité). Les Ampères/Heure indiquent combien d'énergie la batterie peut accumuler.

Charge rapide

Elle sert à charger une batterie dans un délai réduit. Cette fonction utile en situation d'urgence rétablit rapidement la puissance de la batterie mais ne permet pas la charge optimale et nuit à son efficacité si elle est utilisée assez fréquemment.

Courant de démarrage: Amp 0 Volt CC - Amp 1 Volt / el

Indique, avec deux méthodes de mesure différentes, les Ampères qu'un chargeur de batterie distribue grâce à la fonction booster (démarrage rapide) pendant quelques secondes et qui une fois ajoutés à ceux distribués par la batterie, permettent de démarrer un moteur.

0 Volt CC = Courant de pic en démarrage

1 Volt / el = Courant conventionnel de charge EN 60335-2-29 (1V/C)

Courant de charge: moyen/effectif

Indique, avec deux méthodes de mesure différentes le courant que le chargeur transfère à la batterie.

Limitation de tension

La tension de charge est automatiquement limitée afin d'éviter la surcharge et pour éviter l'evaporation de l'électrolyte.

Positions de charge

Sont présentes dans certains chargeurs de batteries et servent à régler les Ampères distribués.

Puissance

Indique combien de puissance doit avoir le réseau électriques pour alimenter le chargeur de batterie.

Tension nominale de la batterie

C'est la tension de la batterie qui doit être rechargée. Chaque batterie se compose de plusieurs cellules à 2 Volts chacune; les batteries les plus typiques sont de 6, 12, 24 Volts.

Type de batteries

Batterie au Ni-Cd

Utilise des composants en Nickel cadmium qui assurent une durée très élevée. A cause de son coût élevé, elle ne peut être utilisée que pour des applications spéciales (telles que systèmes d'alarme, sécurité etc.)

Batterie au plomb à l'électrolyte liquide

Est utilisée dans le secteur de l'auto traction. La batterie se compose de plusieurs éléments dans des agglomérés de plomb (cellules), noyées dans une solution d'eau et d'acide sulfurique.

Batterie au Pb/Gel

Contient de l'acide sulfurique qui, absorbé par le silice, forme un gel. L'avantage de cette solution est l'impossibilité d'avoir des pertes d'acide en cas de retournements ou ruptures. Il est important de ne pas la surcharger pour éviter l'evaporation de l'électrolyte.

Batterie au plomb scellée "sans entretien"

Elle ne peut pas être ouverte pour y ajouter l'électrolyte; il est donc indispensable de ne pas la surcharger pour éviter l'evaporation du liquide. En réalité, même cette batterie présente des trous pour l'évacuation des gaz.

Batterie au Pb/AGM

Contient de l'acide sulfurique, absorbé dans un séparateur de fibre de verre. L'avantage de cette solution est l'impossibilité d'avoir des pertes d'acide en cas de retournements ou ruptures. Il est important de ne pas la surcharger pour éviter l'evaporation de l'électrolyte.

Batterie au Pb/Ca-Ca

Sur les plaques à la fois positifs et négatifs de l'antimoine est remplacée par un alliage de calcium. L'evaporation d'électrolyte et l'auto-décharge est inférieure à celle des batteries d'antimoine.

Batterie au Pb pour traction

Batteries pour véhicules électriques: Chariots élévateurs, balayeuses, etc.



www.decaweld.com



DECA S.p.A.
Strada dei Censiti, 10
Zona Industriale Rovereta
47891 Falciano
Repubblica di San Marino



Tel. **da/from Italy** 0549 910711
from other Countries +378 0549 910711

Fax **da/from Italy** 0549 908360
from other Countries +378 0549 908360
deca@decaweld.com

EU DISTRIBUTOR



DECA DIFFUSION s.r.l.
Via Ausa, 179
Cerasolo Ausa
47853 Coriano (RN)
Italy



Tel. **da/from Italy** 0541 390522
from other Countries +39 0541 390522

Fax **da/from Italy** 0541 309047
from other Countries +39 0541 309047
decadiffusion@decaweld.com



La società produttrice declina ogni responsabilità per le possibili inesattezze contenute nel presente catalogo, imputabili ad errori di stampa o di trascrizione.
The manufacturer does not accept any responsibility for any typing or printing errors in this catalogue.
Le fabricant décline toute responsabilité pour les éventuelles inexactitudes contenues dans ce catalogue, dues à des erreurs d'impression ou de retranscriptions.

AA0101

www.ramstudio.sm

photo: laurentbernardi.com

ОФИЦИАЛЬНЫЙ ДИЛЕР В УКРАИНЕ:

storgom.ua

ГРАФИК РАБОТЫ:

Пн. – Пт.: с 8:30 по 18:30

Сб.: с 09:00 по 16:00

Вс.: с 10:00 по 16:00

КОНТАКТЫ:

+38 (044) 360-46-77

+38 (066) 77-395-77

+38 (097) 77-236-77

+38 (093) 360-46-77

Детальное описание товара: <https://storgom.ua/product/svarochnyyapparatdecamastrotig3-7acdc.html>

Другие товары: <https://storgom.ua/argonno-dugovaia-svarka.html>