

OPERATING INSTRUCTIONS

Reversible vibratory plates

VDR22, VDR26, 26H, VDR32, 32H



ORIGINAL OPERATION MANUAL (2006/42/EC)

NTC STAVEBNÍ TECHNIKA spol. s r.o.
Jiřínková 120, 552 03 Česká Skalice
Czech Republic
Tel: +420 491 452 184
Fax: +420 401 609

e-mail: ntc@ntc.cz, sales@ntc.cz
www.ntc.cz

(06/2009)

ES/EU PROHLÁŠENÍ O SHODĚ (originál)

EC/EU Declaration of Conformity (original)

Prohlašujeme, že zařízení definované níže uvedenými údaji je ve shodě s požadavky níže uvedených NV a směrnic
 We declare that the trough below mentioned specifications defined equipment complies with requirements of below cited Directives

Výrobce (manufacturer): Sídlo firmy (company domicile):	NTC STAVEBNÍ TECHNIKA spol. s r.o. Jiřinková 120, Česká Skalice 552 03
IČ (identification number):	63221152
Osoba pověřená sestavením a uchováváním technické dokumentace: (Person in charge of assembling and storing technical documentation)	NTC STAVEBNÍ TECHNIKA spol. s r.o.
Název (model):	VIBRAČNÍ DESKA REVERZNÍ / REVERSIBLE VIBRATORY PLATE
Typ (type):	VDR22, 26, 26H, 32, 32H
Výrobní číslo (serial number)	
Popis (description):	Vibrační deska reverzní je určena pro zhutňování všech druhů zemi, pro zhutňování příkopů a ploch, jakož i pro zhutňování asfaltových povrchů. Všechny typy vibračních desek řady VDR jsou osazeny usměrněným vibrátorem. Plynulým přesouváním vzájemné polohy nevyvážků se dosahuje změny výslednice odstředivé síly, což umožňuje plynulou změnu pojezdu vpřed i vzad nebo zastavení na místě. Pohon vibrační desky reverzní je zajištěn čtyřdobým jednoválcovým motorem HONDA (čistý výkon: od 3,6 do 6,0 kW) nebo diesellovým motorem HATZ (čistý výkon 3,6 kW). <i>Reversible vibratory plate is suitable for compaction of all sorts of soil, for compaction in trenches and on areas as well as for compaction of asphalt surfaces. All models of the VDR line are equipped with directed vibrator. The vector of the resulting force changes its direction by idenfínite change of the position of the eccentric weights, which enables to smoothly control travel speed forward or reverse or even to stop at spot. The machine is driven with four-stroke single-cylinder engine HONDA (net power 3,6 – 6,0 kW) or diesel engine HATZ (net power 3,6 kW).</i>
Všechna příslušná ustanovení, která výrobek splňuje (The product meets all relevant provisions)	Strojní zařízení – směrnice 2006/42/ES; NV č.176/2008 Sb. <i>Machinery Directive 2006/42/EC</i> Emise hluku – směrnice 2000/14/ES; NV č.9/2002 Sb. <i>Noise Emission 2000/14/EC</i> Elektromagnetická kompatibilita – směrnice 2014/30/EU; NV č.117/2016 Sb. <i>Electromagnetic Compatibility Directive 2014/30/EU</i>
Harmonizované technické normy a technické normy: (The harmonized technical standards and technical standards)	ČSN EN ISO 12100, ČSN EN 500-1+A1, ČSN EN 500-4 EN ISO 14982:2009
Osoby zúčastněné na posouzení shody (Persons involved in the assessment of conformity)	Autorizovaná osoba č. 255 (authorized Body No. 255) Notifikovaná osoba č. 1016 (the European Notified Body No. 1016) Státní zkušebna zemědělských, potravinářských a lesnických strojů, a.s., Třanovského 622/11, 16304 Praha 6-Řepy, ČR <i>The Government Testing Laboratory of Agricultural, Food Industry and Forestry Machines, Joint-stock company</i>
Použitý postup na posouzení shody: (To the conformity assessment applied procedure)	Na základě směrnice 2000/14/ES příloha VI; NV č.9/2002 Sb., příloha č.5 <i>Pursuant to the Directive for Noise Emission 2000/14/EC Annex VI, VII, VIII</i> Na základě směrnice 2006/42/ES příloha VIII; NV č.176/2008 Sb., příloha č.8 <i>Pursuant to the Machinery Directive 2006/42/EC Annex VIII</i>
Naměřená hladina akustického výkonu: (Measured sound power level)	L_{WA} = 103, 104, 104, 104, 103 dB
Garantovaná hladina akustického výkonu: (Guaranteed sound power level)	L_{WA} = 105 dB

Poznámka: Veškeré předpisy byly použity ve znění jejich změn a doplňků platných v době vydání tohoto prohlášení bez jejich citování.
 Note: All regulations were applied in wording of later amendments and modifications valid at the time of this declaration issue without any citation of them.

Místo a datum vydání:
 Place and date of issue:
 Česká Skalice, 23.11.2016

Osoba zmocněná k podpisu za výrobce:
 Signed by the person entitled to deal in the name of producer:

Jméno (Name):
 Ing. Petr Ratsam

Funkce (Grade)
 jednatel společnosti (Company Executive)

Podpis (signature)

Congratulations on purchasing the VDR Series Reversing Vibration Plate Compactor. You have become an owner of a top-quality high-performance heavy-duty compacting machine. Please read these Instructions carefully and follow them when working with the Compactor. This is the only way of protecting health of operators and persons nearby, of providing safe and effective operation and long service life of the machine.

The manufacturer cannot bear any responsibility for any damages caused by not following these Operating Instructions.



1.	SAFETY INSTRUCTIONS	4
1.1	GENERAL SAFETY INSTRUCTIONS FOR WORK WITH SMALL TOOLS AND DEVICES	4
1.1.1	Qualification Requirements	4
1.1.2	Contractor's Obligations	4
1.1.3	Operator's Obligations	4
1.1.4	Machine Operation	5
1.1.5	Inspections, Maintenance & Repairs	5
1.1.6	Loading and Transportation	6
1.2	PROHIBITED OPERATIONS	6
1.3	HYGIENIC PRINCIPLES	7
1.4	ENVIRONMENTAL PRINCIPLES	7
1.5	DISPOSAL OF THE MACHINE AFTER THE END OF ITS SERVICE LIFE	7
1.6	SAFETY INSTRUCTIONS FOR WORK WITH COMPACTING MACHINES	8
1.7	HYGIENIC INFORMATION	8
1.8	LIST OF SAFETY STICKERS (LABELS) USED ON THE MACHINE	9
1.9	DISPOSAL OF THE PACKING MATERIALS	10
1.10	SPECIAL CONDITIONS OF OPERATION.....	10
1.10.1	OPERATION AT LOW AMBIENT TEMPERATURE.....	10
1.10.2	OPERATION AT HIGH ALTITUDES.....	10
1.10.3	OPERATION IN DUSTY ENVIRONMENT.....	10
2.	TECHNICAL DESCRIPTION	10
2.1	BASIC SPECIFICATIONS	11
2.2	LUBRICANTS	12
2.3	BASIC PARTS OF THE REVERSING PLATE COMPACTOR.....	12
3.	PREPARATIONS BEFORE WORK.....	13
3.1	CHECKING THE ENGINE OIL LEVEL	13
3.2	CHECKING THE VIBRATION EXCITER OIL LEVEL	14
3.3	CHECKING THE FUEL LEVEL	15
3.4	CHECKING THE AIR CLEANER	16
4.	STARTING UP THE MACHINE	18
4.1	HONDA PETROL ENGINES	18
4.2	HATZ 1B20 AND 1B30 DIESEL ENGINES (STARTING WITH A STRANDED WIRE)	20
5.	STOPPING THE MACHINE	21
5.1	HONDA PETROL ENGINES	21
5.2	HATZ DIESEL ENGINES (STARTING WITH A CRANKING HANDLE)	23
6.	MAINTENANCE	24
7.	MAINTENANCE SCHEDULE	25
8.	WARANTY TERMS.....	28

Revision No.	Description	Date
1	Updated according to EU Directive 2006/42/EC	01/2010

1. SAFETY INSTRUCTIONS

1.1 General Safety Instructions for Work with Small Tools and Device

1.1.1 Qualification Requirements

As a rule, no machine operator's card is required for work with small tools and devices. Nevertheless, the person in charge of operating small tools and devices individually should meet the following conditions:

1. The persons to be charged with working with small tools and devices should:
 - :- be older than 18;
 - :- be physically and mentally fit for this kind of work;
 - :- be properly trained and have shown the employer their capabilities to operate such machines;
 - :- be expected to work duly and properly according to their supervisors' instructions;
2. Before the work is started, the operator should acquaint himself with the Operating Instructions and to follow them during the work.
3. The operator should acquaint himself with the safety instructions applicable to the respective machine and follow these instructions for the whole time of work. The acquaintance with the instructions should be provable, which means that the operator should confirm this fact by his or her signature.

1.1.2 Contractor's Obligations

The contractor is deemed to be a natural or legal entity in charge with performing the construction work using the given machine. The contractor is responsible for safety of the work with the machine.

The contractor is especially obliged:

- :- To designate the machine operator and to train him duly and properly;
- :- To provide the operator with safe conditions for working with the machine;
- :- To supervise the observance of the respective safety instructions;
- :- To supervise whether the operator follows the respective Operating Instructions;
- :- To provide organizational backup for regular inspections, maintenance and repairs of the machine;
- :- To provide suitable, safe and secured place for storing the machine if not in use.

Moreover, the contractor is obliged to provide organizational backup for observing other legal requirements for labour safety and other regulations applicable to the given workplace.

1.1.3 Operator's Obligations

The machine operator should be designated by the contractor providing always that the provisions of Par. 1.1.1 above are met.

The operator is especially obliged:

- :- To acquaint himself with the Operating Instructions including the applicable labour-safety rules before the work is started;
- :- To follow all the provisions of the Operating Instructions;
- :- To acquaint himself with the workplace itself including the labour-safety rules applicable for the given workplace and to follow the rules;
- :- To pay full attention to the machine operation;
- :- To provide organizational backup for regular inspections, maintenance and repairs of the machine;
- :- To require the employer to provide the conditions for following the safety instructions, for carrying out regular inspections, maintenance and repairs of the machine.
- :- To prevent the machine from being damaged or stolen and from unauthorized use. To store the machine in a safe and duly secured place after work.

1.1.4 Machine Operation

When working with the machine, the operator or the operating staff should follow the following instructions:

1. Check the machine, especially all its protective elements (e.g. covers) and controls. Make sure that there are no leaks of fuel from the fuel system or oil from the engine. Should a defect is found, the machine must not be operated until the defect is repaired.
2. Use personal protective means (such as the respective crash helmet, ear protectors, protective goggles, gloves, shoes). The protective clothing should be close-fitting, not loose. Loose or damaged (torn) clothing should not be used. Any chains, watches, rings, etc. should not be worn as they can be caught by rotating parts of the machine and injure the operator.
3. Before work, check whether the machine can be safely started up without endangering the operating staff or other persons nearby.
4. Do not start up the engine in closed spaces unless sufficient ventilation is provided.
5. Pay full attention to the machine operation to prevent injury or collision with solid obstacles, other machines or vehicles.
6. Listen the run of the machine carefully. In case of unusual sounds or if smoke appears, stop the machine immediately check the machine and get it repaired.
7. Fill the machine with fuel only at standstill. The fuel must not come into contact with hot parts of the machine. If the fuel is spilled over, wipe up the fuel immediately. Do not fill the tank up to the neck.
8. See to it that that the fuel tank cap is tight. If not in operation, the fuel valve should be closed. If the machine is transported for a longer distance the fuel tank should be emptied.
CAUTION – broken or leaking fuel tanks and fuel piping can cause explosion, it is necessary to replace them without delay.
9. The machine should not be operated everywhere where there is danger of explosion of combustible gases or dust.
10. When operating the machine in closed spaces (tunnels, shafts, deep holes, etc.), the operator should be provided with fresh air supply (see the applicable regulations for constructional work).
11. After the work is finished, stop the engine, put the machine in a safe place, secure it against theft or unauthorized use. The machine should be stored in such a manner that it cannot fall down or overturn and that it is not an obstacle to other machines and vehicles.

1.1.5 Inspections, Maintenance & Repairs

1. Check the technical condition of the machine regularly and focus on perfect functioning of protective and control elements. If a defect is found, have it repaired without delay.
2. Machine servicing may only be carried out by a duly qualified person authorized by the contractor. Machine servicing can also be carried out by the worker of the respective service organization.
3. The machine should be serviced in a clean and safe place. If possible, service the machine in a workshop with the adequate equipment. If it is necessary to service the machine in-situ, the place should be secured in such a manner that any collision with other machines or vehicles is eliminated. The machine should not be serviced in otherwise dangerous places (landslides, cave-ins, operation of other machines and vehicles etc.).
4. Service the machine at standstill with the engine off only. If there is a need for starting up the engine when servicing the machine, pay full attention to labour safety.
5. When repairing the machine, use the original spare parts only. Only original spare parts (that have been tested and approved by the manufacturer) can guarantee safe operation of the machine.

6. Any changes and modifications of the machine can only be made with the manufacturer's express consent.

1.1.6 Loading & Transportation

1. The machine may only be loaded and transported using a device or a vehicle with the lifting or loading capacity corresponding to the weight of the machine (see "Basic Specifications").
2. When loading the machine with a crane, all the regulations applicable to work with a crane should be observed. This should be done by a duly qualified person(s).
3. The sling should be placed in the marked place on the machine frame.
4. When handling the machine manually, more persons is necessary in order not to exceed maximum permissible weight to be lifted by one person.
5. During transportation, the machine should be sufficiently secured against overturning, falling or shifting. The slings should be fixed on the marked place(s).
6. During transportation, the shaft of the machine should be lifted and duly fixed in position.
THE CONTROL SHAFT (SEE 2.1 BASIC PARTS OF THE REVERSING PLATE) SERVES FOR CONTROLLING THE MACHINE ONLY IF VIBRATION IS ON (working, i.e. maximum speed is set). **THE VIBRATING PLATE SHOULD NEVER BE LIFTED, TURNED, FIXED, TOWED, ETC. USING THE CONTROL SHAFT AS ITS RESILIENT MOUNTING WOULD BE DAMAGED.**
IN CASE OF DAMAGE DUE TO MACHINES FROM THIS COMPANY IS NOT RESPONSIBLE FOR DAMAGES!

1.2 Prohibited Operations

It is strictly prohibited:

- :- To use the machine for purposes other than those the machine is intended for;
- :- To control the machine in a different way from that set forth in the Operating Instructions;
- :- To operate the machine under influence of alcoholic beverages or drugs;
- :- To operate the machine in such a manner that safety of persons, buildings, structures, things or road traffic and its smoothness is endangered.
- :- To operate the machine if other persons are within the working radius of the machine;
- :- To operate the machine with any of its protective elements removed or damaged;
- :- To operate the machine in dangerous areas with imminent external danger such as caving-in the machine, landslides, overturning the machine, release of dangerous substances, risk of explosion or fire, electric shock hazard, etc.)
- :- To operate the machine in the areas where buildings, other structures or underground services could be damaged (e.g. by excessive vibrations).
- :- To operate the machine within the protective zones of electric lines and transformer stations;
- :- To cross electric cables with the machine unless they are sufficiently protected against mechanical damage;
- :- To operate the machine at poor visibility or at night without sufficient illumination of the whole workplace;
- :- To leave the machine while in operation or to leave the machine without having secured it against unauthorized use;
- :- To deactivate safety and protective elements or to change their parameters;
- :- To operate the machine with leaking oil, fuel or other liquids;
- :- To start up the engine in a manner different from that mentioned in the Operating Instructions;
- :- To clean the machine or to remove dirt while in operation;
- :- To smoke or use open fire when fueling or lubricating the machine, when checking the fuel level or the accumulator.

1.3 Hygienic Principles

Oil products (fuels, lubricants) are substances dangerous to health. Workers who come into contact with these substances when operating, maintaining or repairing machines should observe general principles of health protection and follow the hygienic and safety instructions issued by manufacturers of such substances. They are especially obliged:

- :- To protect their skin from coming into contact with such substances;
- :- To wash their hands thoroughly after work, before eating and to put a suitable regenerating cream on them.

Oil products as well as other detergents, preservatives and dangerous substances should at all times be stored in original, properly marked containers. Never allow storing such substances in different containers, in unlabelled containers or in food containers or bottles in order to prevent confusion. Store such substances out of the reach of children. If such substance come into contact with the skin, eyes or if inhaled or ingested, apply the first-aid measures and seek medical attention immediately.

1.4 Environmental Principles

Fuels, lubricants and operating liquids in individual systems of the machine are dangerous for the environment. After the end of their service life, they become dangerous waste materials. Moreover, the parts of the machine that come into contact with the above substances are also dangerous (e.g. filters). Please prevent these substances from their getting into soil or water (including sewerage systems). These substances should be stored in such a manner that all accidental spills can be caught. If such substances are released when refueling or lubricating the machine, dispose them in a proper and safe manner (sprinkle them with an absorbent, have them disposed by a specialized firm). Dispose the used liquids according to the respective regulations.

1.5 Disposal of the Machine after the End of Its Service Life

When disposing the machine after the end of its service life, the user is obliged to comply with all the applicable legal regulations. When disposing the machine, the oil filling from the engine and the vibrating mechanism as well as the respective filters should be removed. Pursuant to the Waste Material Disposal Act, the owner of the disposed machine is obliged:

- :- To hand over the metal parts of the machine only to those persons who are duly authorized to dispose, collect or purchase metal materials;
- :- To hand over the used engine and hydraulic oil only to those persons who are duly authorized to dispose used oils;

NTC cannot be held responsible for any damages to the user's health or to the environment if the aforementioned hygienic and environmental principles are not observed.

1.6 Safety Instructions for Work with Compacting Machines

Compacting machines are vibration plates, vibration (jumping) rammers and vibration rollers. When working with these machines, the following safety instructions should be followed:

1. Before work, evaluate the bearing capacity of the terrain, locate the places of underground spaces and underground services to prevent caving-in the machine or damaging the underground structures.
2. When working with the machine close to buildings and structures, bear in mind the possibility of damaging the buildings or structures by vibrations.
3. When operating the machines in excavation pits, secure the walls of the pit to prevent them from sliding and causing injury to the operators.
4. When operating the machines on embankments, do not work on the very edge of the embankment so that it should not slide down causing turning the machine over.
5. It is strictly prohibited to operate the machine on such slopes where there is danger of turning the machine over or of loss of adhesion resulting in an uncontrolled skid of the machine.

1.7 Hygienic Information**Noise:**

Declared level of acoustic pressure A in workplace of the operator

(measured according to ČSN EN ISO 11201 by conditions determined in ČSN EN 500-4, Annex B)

	VDR22	VDR26	VDR26H	VDR32	VDR32H
L_{pA,d} [dB]	92+4	91+4	91+4	87+3	90+1

Guaranteed level of acoustic power A

(measured according to NV č.9/2002 Sb., Annex č. 3, part B, point 9c) and ČSN EN ISO 3744:2010)

	VDR22	VDR26	VDR26H	VDR32	VDR32H
L_{WA,G} [dB]	105	105	105	105	105

Vibration:

Declared overall value of vibrations acceleration – transferred to hand – arm of vibratory plate operator (measured according to ČSN EN ISO 20643 by conditions determined in ČSN EN 500-4, Annex C).









	VDR22	VDR26	VDR26H	VDR32	VDR32H
a_{hvd} [m.s⁻²]	13,9+5,5	3,2+1,6	8,5+3,4	8,6+3,5	9,3+3,7

With regard to value of declared level of acoustic pressure in operator's area and value of vibrations transferred to operator's arms, when operating particular type of vibratory plate it is necessary to use, in accordance to Government regulation no. 272/2011 Sb. in valid version, personal protection equipment effectual in such level of acoustic pressure or vibrations transferred to arms, whose values for particular type of vibratory plate are determined by machine operator by workplace categorization.

Manuals for operation of vibratory plate must be modified so, that there are obvious technological pauses leading to interruption of operator machine usage.

1.8 List of Safety Stickers (Labels) Used on the Machine

At the designated types of machinery vibration plate types VDR22 VDR32H to comply with the Act No. 22/1997 Coll. on technical requirements for products, as amended, located stickers symbols safety signs, symbols and informative descriptions of the design and implementation determine the technical norm. The following text shows individual stickers (labels) placed on the machine. Each individual sticker is provided with the respective explanatory text.

<p>1.</p>	<p>A united sticker comprising safety signs according to ČSN ISO 3864 (symbols B.2.5, B.3.1 and NB.2.26) and including the explanatory text. Sign B.2.5 orders the operating staff to wear ear protectors when the machine is in operation. Sign 7.28 informs the operating staff that they are obliged to read the Operating Instructions before work with the machine. The NB.2.26 sign orders the operating staff (operators) to wear protective gloves when working with the machine to protect the hands from vibrations. Warning sign B.3.1 (exclamation mark) warns the operators against danger. Information for the operating staff how to perform repairs, cleaning and setting the machine.</p>	
<p>2.</p>	<p>Sticking label No. 7.25 pursuant to ČSN ISO 6405-1 (the symbol marks the hoisting point, (i.e. the place in which the machine can be hoisted).</p>	
<p>3.</p>	<p>Sticking label No. 8.1 pursuant to ČSN ISO 6405-1 marks the location of the engine oil discharging screw.</p>	
<p>4.</p>	<p>A sticker informing the operating staff about the fuel to be used for the engine of the machine.</p>	
<p>5.</p>	<p>A sticker informing the operator how to operate the travel control lever.</p>	
<p>6.</p>	<p>A sticker showing symbols of a turtle and a running hare to mark idle running and the maximum (i.e. working) speeds of the machine pursuant to ČSN ISO 6405-1.</p>	
<p>7.</p>	<p>A sticker showing the noise level measured according to the conditions set forth in NV 9/2002 Sb.</p>	
<p>8.</p>	<p>Sticker indicating the illegal ways of dealing with the board.</p>	

1.9 Disposal of the Packing Material

The company of *NTC STAVEBNÍ TECHNIKA spol. s r.o.* is registered with the *EKO-KOM a.s.* company. This means that there is a contract between *EKO-KOM a.s.* and *NTC STAVEBNÍ TECHNIKA spol. s r.o.* on repurchase of all kinds of packing materials either by *NTC* or by suppliers of the packing materials.

1.10. Special conditions of operation

1.10.1. Operation at low ambient temperature

Compaction at temperature below freezing is highly dependent on water content in the soil to be compacted. Under such conditions, soil becomes harder and more difficult to compact. It is possible to compact dry materials or rapidly compact fresh soil, before it gets frozen.

1.10.2. Operation at high altitudes

With increasing altitude, engine power decreases due to changed oxygen content. Within certain extent, it is possible to improve the engine power by installing different main nozzle and by adjusting the carburetor (gasoline engines) or by adjusting the injection system (diesel engines). Should the machine be operated in high altitudes (above 1500 m above sea level), contact the engine manufacturer to carry out the adjustments.

In case that you intent to operate the machine in high altitudes in the time of purchase, consult the manufacturer.

1.10.3. Operation in Dusty Environment

In case that the machine is operated in extremely dusty environment, it is recommended to shorten the service intervals for cleaning or replacement of the air filter.

Clean the machine from dust regularly.

2. TECHNICAL DESCRIPTION

Our Reversing Vibration Plates are intended for the compacting of all kinds of soils, ditches, various surfaces as well as for compacting paved surfaces.

The centrifugal force of the vibrator is optimized according to the weight of the machine and the size of the working surface in order to achieve high compacting performance.

The VDR Series vibration plates are provided with a directional vibrator. Step less shifting of the mutual position of the unbalanced elements leads to the change in the direction of the resultant centrifugal force which further results in smooth change of the machine travel forwards and backwards or in operating the machine without any travel. The compacting part is the bottom plate with the vibrator. The base of the engine is resilient-mounted on the plate. The vibration plate is driven by a four-stroke single-cylinder engine. The frequently used engines are the HONDA petrol engines and the HATZ diesel engines. The engine is connected with the vibrator with a V-belt. The transmission of the torsional moment (T.M) is interrupted (during idle run of the engine) by a centrifugal clutch on the engine shaft.

The operator controls the machine using a resilient-mounted tilting handle with two levers – travel lever and throttle control lever. If the engine is electronically controlled, the throttle control lever is replaced by an idle-speed and working-speed switch.

Special accessories for VDR 22 and VDR 26 can include a special undercarriage to transport the vibration plate and a buffer plate.

2.1. Basic specifications:

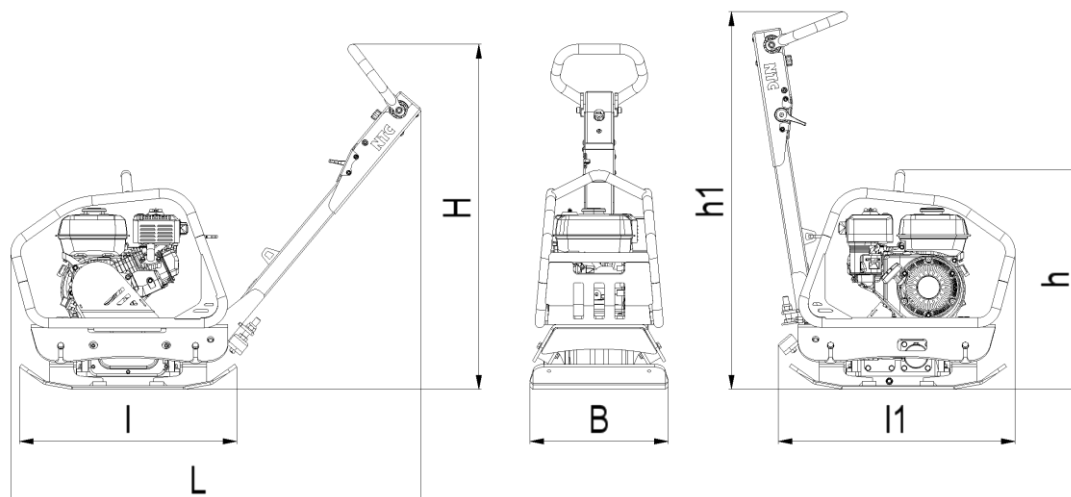

Type	Machine dimensions [mm]						
	B	H	h	h1	L	I	I1
VDR22	400	990	630	1090	1180	630	685
VDR26	450	1000	700	1100	1220	700	715
VDR26H	450	1000	700	1100	1225	700	725
VDR32	500	1040	750	1130	1290	750	790
VDR32H	500	1040	750	1130	1300	750	800

Type		VDR22	VDR26		VDR32	
Model		VDR22	VDR26	VDR26H	VDR32	VDR32H
Weight	[kg]	120	160	170	210	215
Frequency	[Hz]	100	95	95	90	90
Centrifugal Force	[kN]	22	26	26	32	32
Maximum Speed Forwards/Backwards*	[m/min]	24	22	22	22	22
Maximum Climbing Ability	[%]	30	30	30	30	30
Vibratory Plate Width	[mm]	400	450	450	500	500
Vibratory Plate Length	[mm]	630	700	700	750	750
Engine	[-]	HONDA	HONDA	HATZ	HONDA	HATZ
Model	[-]	GX 160	GX 200	1B20	GX 200	1B20
Fuel	[-]	Petrol	Petrol	Diesel	Petrol	Diesel
Engine Output**	[kW]	3,6	4,1	3,4	4,1	3,4
Starting	[-]	manual	manual	manual	manual	manual

* The speed under optimum conditions – the difference between the forward speed and backward speed is +/- 15% per cent.

** Performance of engine is according to SAE J1349 for engines HONDA and according to ISO 3046-1 for engines HATZ

Actual output of the engine installed in the machine can be different with regard to various factors, such as operation speed of the engine, operation conditions, maintenance and other factors. Engine operation speed is not identical with engine rated speed and this is set according to technical parameters of the machine.

2.2. Lubricants

- Engine Oil	15W-40	filling - HONDA GX - 0,6 l filling - HATZ 1B20 - 0,9 l	
- Oil in the Vibrator	15W-40	VDR 22, 26 a 26H, 32 a 32H	Volume: 0,4 l
- Hydraulic Oil	OH-HV 68	VDR 22, 26 a 26H, 32 a 32H	Volume: 0,2 l

For HONDA engines use brand-name oils of the SAE 15W/40 viscosity class. The performance classification should be e.g. API SG/CF 4 or API SG/CE. See recommendations of HONDA.

For HATZ engines, it is recommended to use oils of performance classification API - CD/CE ú CF/CF-4/CG-4.

For vibrators use brand-name oils of viscosity class SAE 15W-40 and performance classification API SJ/CF.

2.3. Basic Parts of the Reversing Plate Compactor

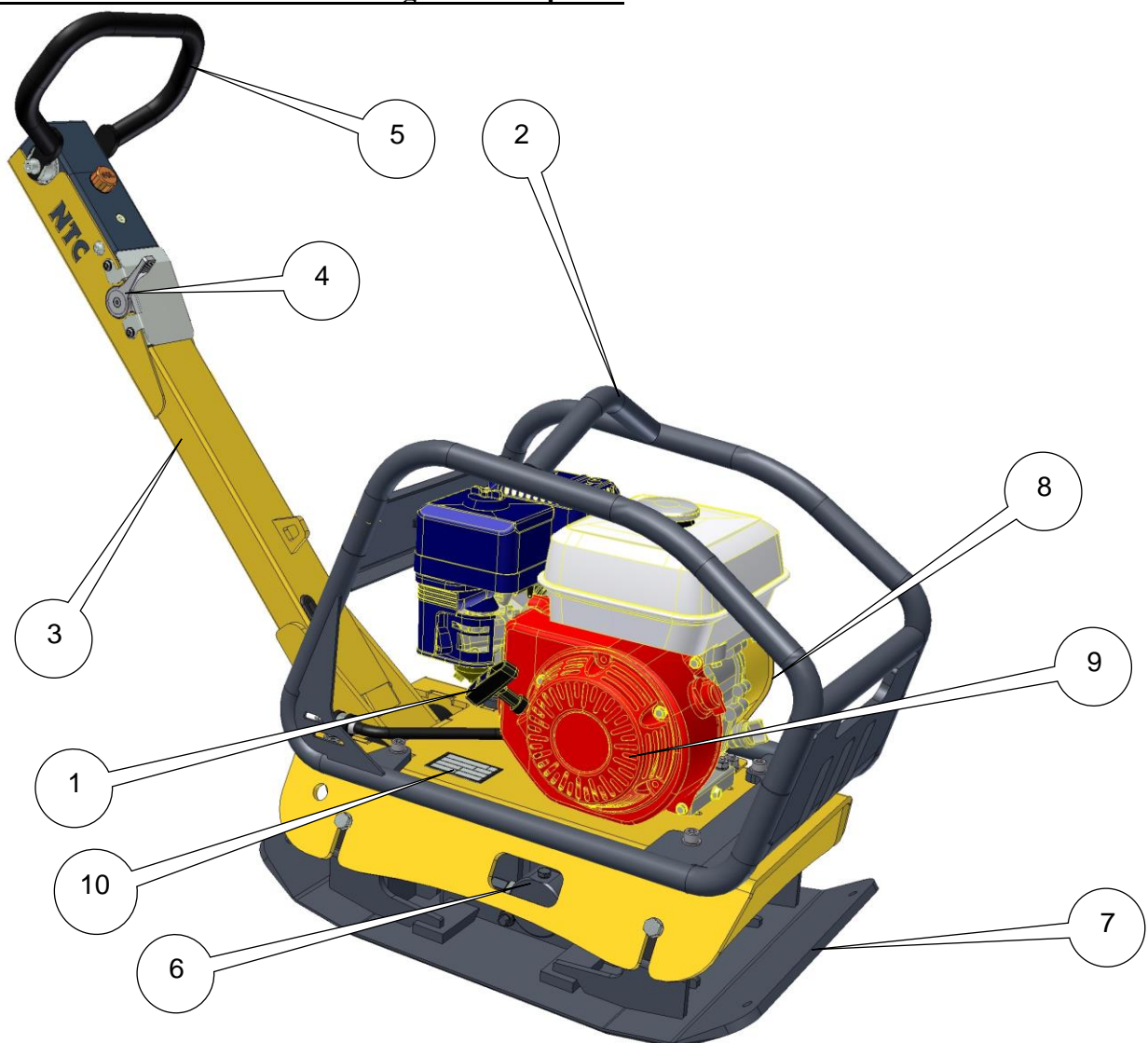

Basic Parts of the Reversing Plate Compactor

1. Stranded wire to start-up the engine, 2. Hoisting point, 3. Control shaft, 4. Gas lever 5 Throttle control lever, travel control lever, 6. Vibrator, 7. Compacting plate, 8. V-belt cover (on the reverse side of the engine), 9. Engine, 10. Machine data plate

3. PREPARATIONS BEFORE WORK

3.1 Checking the Engine Oil Level

Checking the engine oil level on a regular basis is recommended even with the machines provided with the oil-level sensor. With the machines without the sensor, everyday checking is absolutely essential. Use recommended kinds of oils only. The oil viscosity should correspond to the temperature conditions at the workplace.

CAUTION: Operating the engine with a low oil level may cause serious damage to the engine. In case of any oil leakage, stop the engine immediately and call an authorized serviceman or contact the manufacturer.

Check the oil level every day.

Checking the oil level in HONDA GX engines should be carried out as follows:

Place the machine into a horizontal position.

Clean the plug (1) and unscrew it from the filler (2) on the engine.

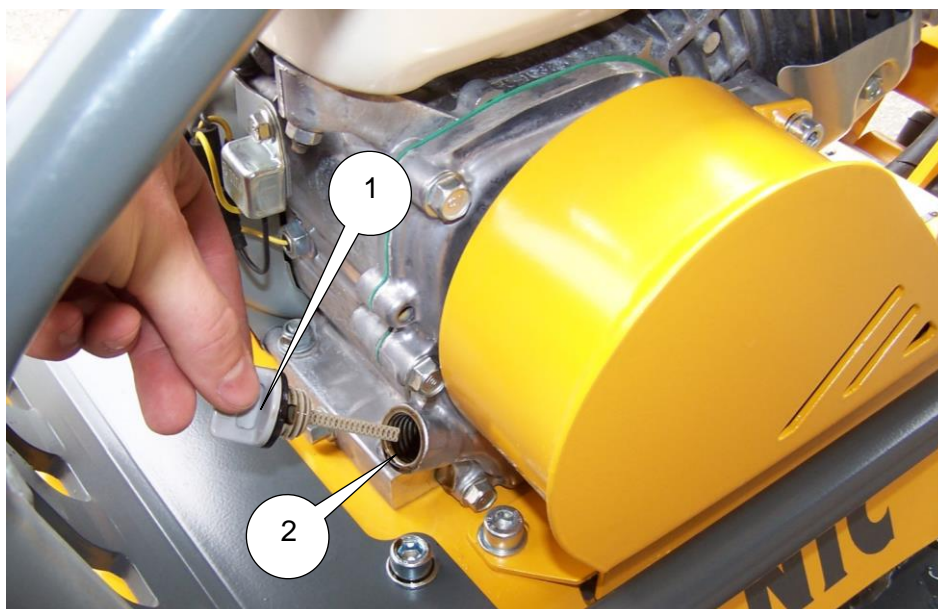

At correct oil level, it just reaches the filling hole edge and the oil slowly flows over it. Should the oil level be below the edge, add oil immediately.

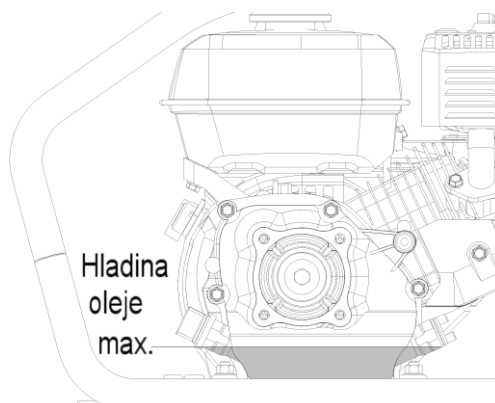

In case of any oil leakage, stop the engine immediately and call an authorized serviceman or contact the manufacturer.

Checking the oil level in HATZ 1B20 engines should be carried out as follows:

Place the machine into a horizontal position.

Clean the plug (1) and unscrew it from the filler (2) on the engine.

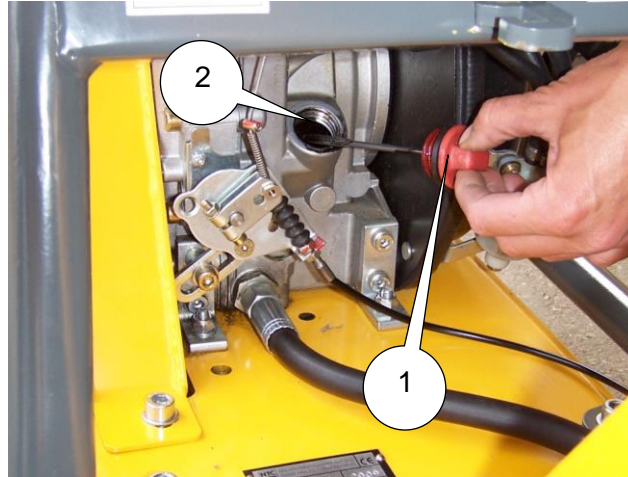

Clean the filler cap with the dipstick with a clean cloth.

Screw the dipstick into the filler and unscrew it again. The oil level should be between the “MIN” and “MAX” marks at the dipstick.



Should the oil level be below the “MIN” mark, add recommended oil into the engine, up to the upper mark “MAX”.

In case that any oil leakage is found, stop the machine immediately and call service or contact the manufacturer.

3.2 Checking the Vibration Exciter Oil Level

It is enough if the check of the vibration exciter oil level is performed once a year during the regular service inspection. It is recommended to get this made by an authorized serviceman.

For inspection of oil level unscrew the plug (1). If correct, oil slightly flows out. Replace the plug.



In the case of low oil level, contact authorized service.

All kinds of repairs of the vibrator within the warranty period may exclusively be carried out by an authorized service or by the manufacturer. Unauthorized intervention will cause the warranty to become void.

CAUTION:

A low or high level of oil may cause serious damage to the vibration exciter bearings.

3.3 Checking the Fuel Level

1. In petrol engines, use standard motor vehicle 90 octane petrol or higher. If the fuel level is low, refill it up to the edge (1) of the filter screen.

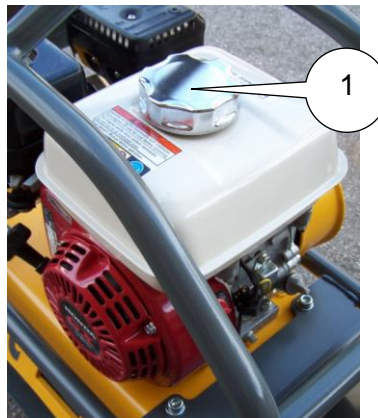

Never use a mixture of oil and petrol or a contaminated petrol. Prevent dirt, dust or water from getting into the fuel tank.

2. In diesel engines, use Diesel oil according to the following standards:
 - CEN EN 590 or possibly DIN/EN 590
 - DIN 51 601
 - BS 2869: A1 and A2
 - ASTM D 975-88: 1-D and 2-D
 - VV-F-800C: DF-A, DF-1 and DF-2
 - NATO code F-54 and F-75

At the temperatures below 0°C (32°F) use the winter kinds of Diesel oils or mixtures of the Diesel oil with special additives or possibly with kerosene to prevent paraffines from being liberated and deposited in the machine fuel system. Offer for Diesel oil at individual filling stations usually reflects the season of the year.

To add fuel, lift the lock (1) first and then release the tank cap pulling it upwards.

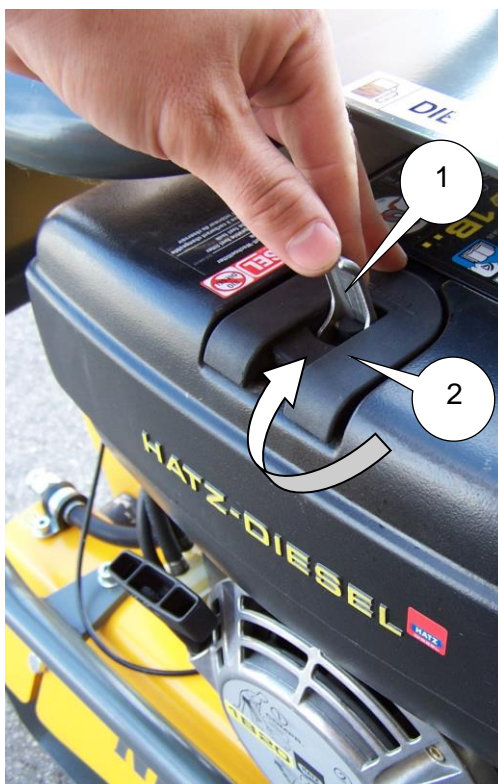

Replace the plug after refuelling.

3.4 Checking the Air Cleaner

Air filter for HONDA engines:

Unscrew the wing nut (1) and remove the plastic air filter cover (2).

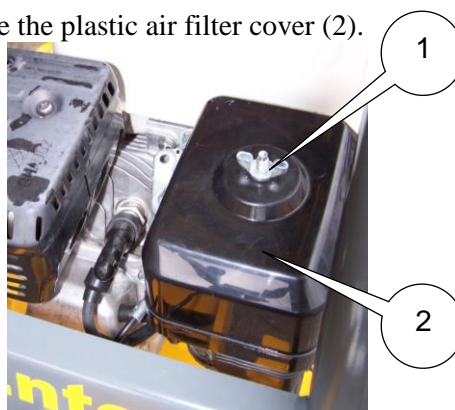

Unscrew the wing nut (1) and remove the air filter element (2).

Remove the foam collar (3).

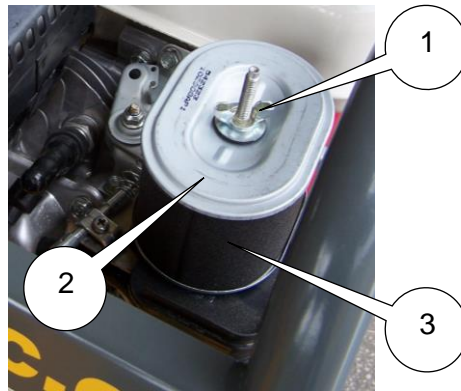

Check the paper filter element to make sure that it is clean and in good order. Clean the paper filter element carefully blowing it off with compressed air from inside. Replace if too dirty.

Wash the foam collar in soap water, never in any solvent!!! Replace if damaged.

Replace all parts carefully.

Never operate the engine with the air filter removed. Dust and dirt taken inside the engine through the carburettor would cause its rapid damage.

Air filter for HATZ 1B20 engines:

Unscrew the plastic wing nut (1) and remove the plastic air filter cover (2).

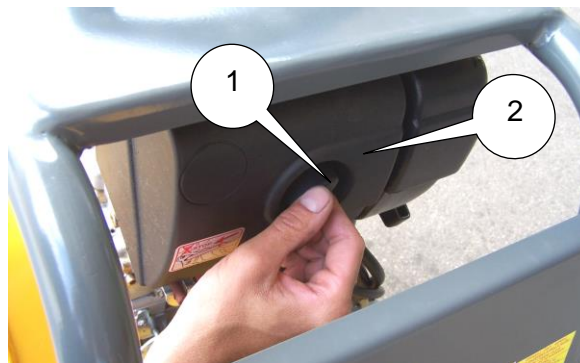

Unscrew the nut (1) and remove the paper filter element (2).

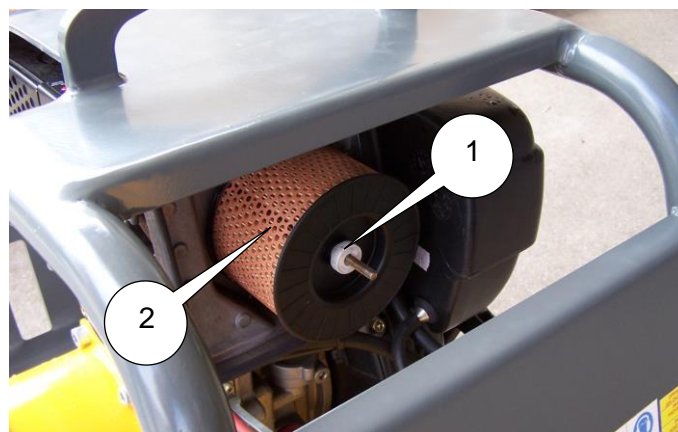

Check the paper element of the air filter to ensure it is clean and in good condition. Clean the air filter element carefully in direction from inside to outside, using pressured air. In case of serious impurity replace the air filter element. Re-install all removed parts carefully. **Never operate the engine without the filter or with a damaged one. Dirt and dust entering the engine would cause its rapid damage.**

4. STARTING UP THE MACHINE

4.1 HONDA Petrol Engines

HONDA GX

1. Put the fuel valve into the "ON" position (1).

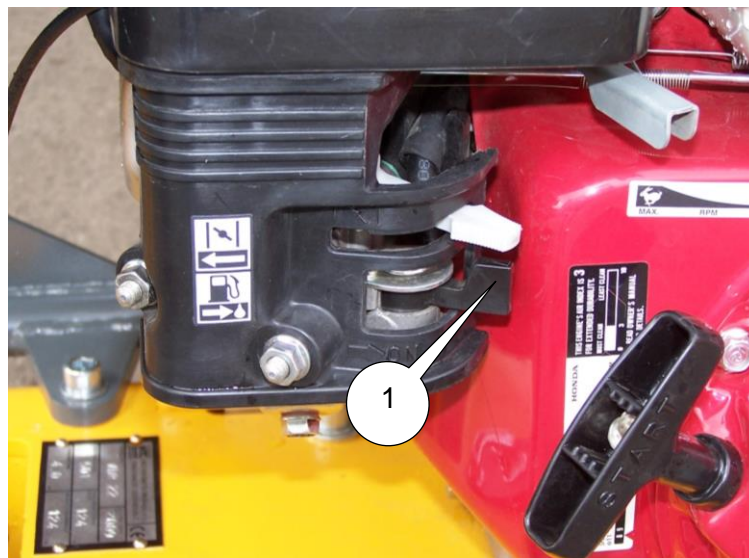

2. Turn on the ignition switch (1) (the ignition switch is located under the cover with the machine model identification).



- Put the choke into the ON position (1). Do not use the choke if the engine is hot or at higher ambient temperatures.

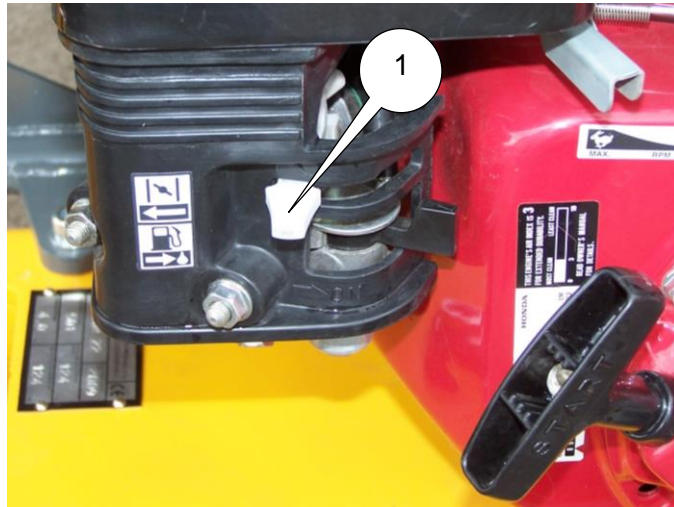

When operating the HONDA Engines, follow the Honda operating instructions.

- Put the control lever in the idle-run position (1).



- Pull the handle of the starting wire a little until you feel a resistance. Then pull the wire swiftly. Do not release the handle quickly but hold it by hand on its reverse movement.
- After the engine heats up put the choke lever into the OPEN position.
- Let the engine heat up sufficiently before work.
- Put the throttle lever to the full throttle position (1). At approximately 1,700 r.p.m., the centrifugal clutch is automatically activated and the machine starts to vibrate.

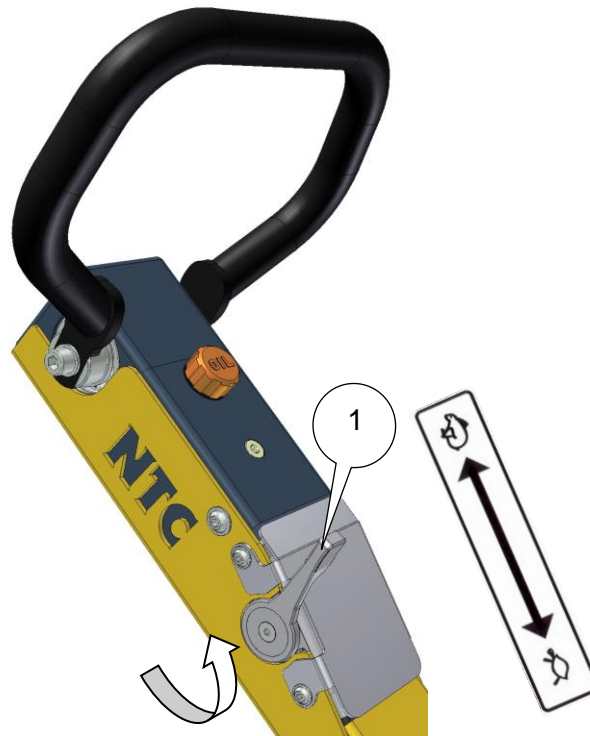

9. The travel control lever will automatically move forward and the machine will start travelling forward.
10. Pull the travel control lever backwards to make the machine travel backwards.

Travel Forward

Travel Backward



4.2 HATZ 1B20 and 1B30 Diesel Engines (Starting with a Stranded Wire)

1. Set the throttle control lever (see 4.2.1) into the idle-run position (a little bit above its extreme position).
2. Pull the handle of the starting wire a little until you feel a resistance. Then pull the wire swiftly. Do not release the handle quickly but hold it by hand on its reverse movement.
3. Let the engine heat up sufficiently before work.
4. Put the throttle control lever into the "full throttle" position (1). At approximately 1,700 r.p.m., the centrifugal clutch is automatically activated and the machine starts to vibrate.

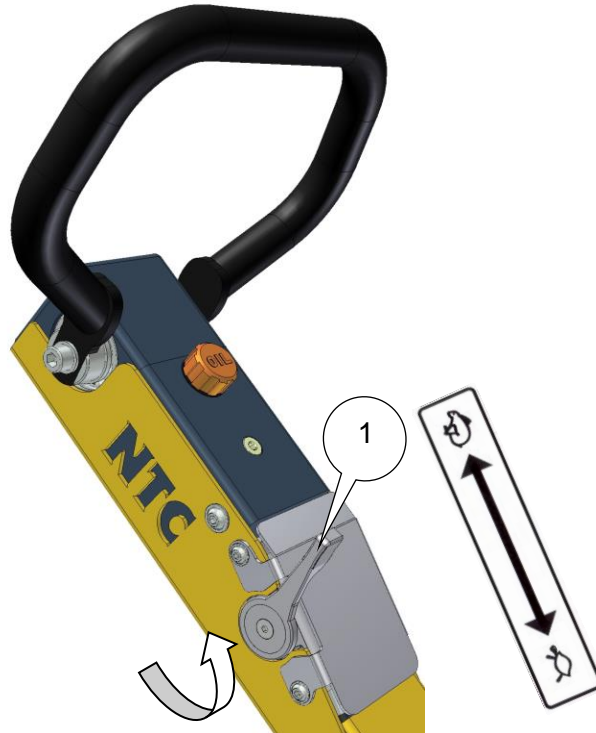

- 5 The travel control lever will automatically move forward and the machine will start travelling forward.
- 6. Pull the travel control lever backwards to make the machine travel backwards.

Travel Forward



Travel Backward



5. STOPPING THE MACHINE

5.1 HONDA Petrol Engines

- 1. Put the throttle control lever into the "0" position (idle run) (1). The centrifugal clutch declutches and the engine stops vibrating.



2. Set the ignition switch to "OFF" (1).



3. Set the fuel valve (1) to "OFF".

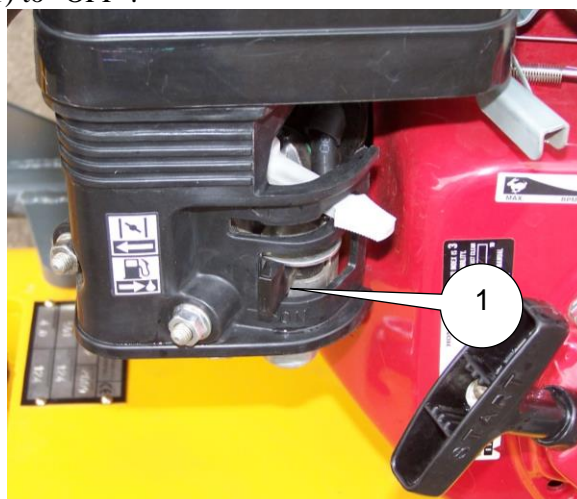

5.2 HATZ Diesel Engines

1. Put the throttle control lever (1) into the "0" position (idle run). The centrifugal clutch declutches and the engine stops vibrating.



2. Push red button (1) for 2-3 seconds to shut-off the engine.

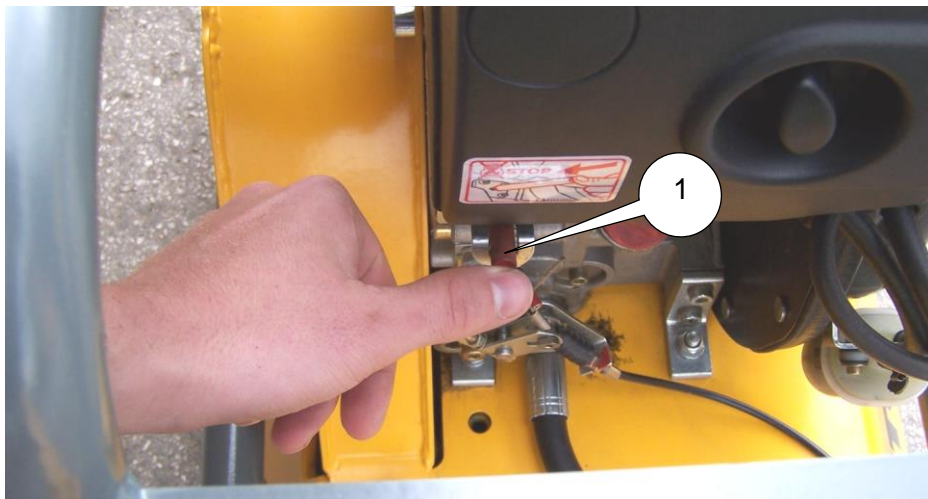

6. MAINTENANCE

1. For the engine maintenance see the attached separate operating instructions.
2. Tightening the V-belt of the vibration exciter drive:
The V-belt can be tightened (see Par. 7 of the Maintenance Schedule)
3. Checking the bolted connections:
It is recommended to check the bolted connections every time before starting up the engine.
4. Setting the engine speed:
After any possible repair or replacement of the HONDA GX engine, the speed of the engine has to be set (see the Maintenance Schedule, Box 7 – Vibration Exciter).
The speed of the HONDA iGX engine is set by the respective computer software and it cannot be changed.

IT IS STRICTLY PROHIBITED TO INCREASE THE SPEED SETTING BEYOND THE DETERMINED LIMIT

otherwise the machine can be destroyed by excessive vibrations.

The manufacturer cannot recognize any claims or complaints caused by setting the speed beyond the limit determined.

DURING THE WARRANTY PERIOD, THIS SETTING MUST BE MADE BY AN AUTHORIZED SERVICE CENTRE.

7. MAINTENANCE SCHEDULE

The Maintenance Schedule includes only the most important operations. Other maintenance operations and repairs beyond this Schedule should be carried out depending on the operating conditions and according to the engine operating instructions. **CAUTION: Switch the engine off before any maintenance operation. Use the original spare parts only otherwise the vibration plate can be damaged and the respective complaint will not be recognized by the manufacturer.**

Maintenance Schedule for Engines HONDA GX

Item	Operation	First Inspection	After the first month or after the first 20 hours of operation	Every 3 months or after every 50 hours of operation	Every 6 months or after every 100 hours of operation
Engine Oil	Oil level check	<input checked="" type="checkbox"/>	DAILY		
	Renewal		<input checked="" type="checkbox"/>		<input checked="" type="checkbox"/>
Air Cleaner	Check	<input checked="" type="checkbox"/>	DAILY		
	Cleaning			<input checked="" type="checkbox"/> (1)	
Sparking Plug	Check - cleaning				<input checked="" type="checkbox"/>
Fuel Hose	Check - replacement	Every two years (2)			
Valve Clearance	Check - adjustment	Every year or every 250 hours of operation (2)			
Fuel Tank & Screen	Cleaning	Every year or every 300 hours of operation (2)			
Sedimentation Glass	Cleaning				<input checked="" type="checkbox"/>
Vibration Exciter	Frequency adjustment	Every year or every 300 hours of operation (2)			
	Exchange of ooil				
Rubber Springs	Check	150 hours of operation			
Hydraulic Oil	Inspection for tightness	Every year or every 300 hours of operation (2)			
V-belt	Inspection for tensioning, inspection of pulleys and clutch				<input checked="" type="checkbox"/> (2)

- 1) **If the engine is operated in a dusty environment, the maintenance operations should be more frequent.**
- 2) **These maintenance operations should be carried out by a NTC serviceman or by an authorized service centre depending on the engine type, especially if the user does not have sufficient knowledge or tools.**

Maintenance Schedule for Engines HATZ 1B20

Item	Operation	First Inspection	After 25 hours of operation (new engine or engine after overhaul)	Every 250 hours of operation	Every 500 hours of operation
Engine Oil	Oil level check	<input checked="" type="checkbox"/>	DAILY		
	Renewal		<input checked="" type="checkbox"/>	<input checked="" type="checkbox"/>	
Air Cleaner	Check	<input checked="" type="checkbox"/>	DAILY		
	Cleaning				<input checked="" type="checkbox"/> (1)
Fuel Injection system	Check - cleaning	Every year or 250 hours of operation (2)			
Filter Vessel	Exchange				<input checked="" type="checkbox"/>
Fuel Hose	Check - replacement	Every two years			
Valve Clearance	Check - adjustment			<input checked="" type="checkbox"/>	
Vibrator Exciter	Frequency adjustment Exchange of oil	Every year or 300 hours of operation (2)			
Rubber Springs	Check				150
Hydraulic Oil	Inspection for tightness	Every year or 300 hours of operation (2)			
V-belt	Inspection for tensioning, inspection of pulleys and clutch				<input checked="" type="checkbox"/> (2)

- 1) **If the engine is operated in a dusty environment, the maintenance operations should be more frequent.**
- 2) **These maintenance operations should be carried out by a NTC serviceman or by an authorized service centre depending on the engine type, especially if the user does not have sufficient knowledge or tools.**

8. WARRANTY TERMS

Construction machines manufactured by NTC are designed and manufactured to suit longterm operation by most difficult conditions. Based on our experience we can say that these machines do work reliably not during the warranty period but also long time after the warranty expires.

If it happens that the machine does not work to your satisfaction, we are always here to help. In case of any failure please proceed as following:

1. Check if the failure isn't caused by breaking operation manual or if it isn't caused by a basic cause (not enough fuel in the tank, low level of engine oil, dirty air filter).
2. If you were unable to fix the failure, contact the manufacturer or its authorized service (see warranty protocol).
3. Mention following info there:
 - Company name, your name, phone and fax number
 - Machine type, serial number
 - Type of failure
 - If the machine is in warranty, write date of purchase and let the serviceman know it is a warranty case
4. Warranty claim needs to be done in written form, best if Warranty claim form is used.
5. Every warranty claim will be checked by authorized staff immediately and the way of repair will be suggested.

Warranty conditions are described in the agreement with particular distributor.

- The right for warranty expires in following cases:
 - Machine was not used and maintained according to operation manual or was damaged by inadequate intervention by operator or unauthorised service
 - Machine was not serviced according to maintenance plan in operation manual
 - Machine was used in different conditions or for different purpose than it is determined to
 - Other refills or spare parts than recommended were used for repair or maintenance
 - Machine had an accident or was damaged by force majeure
 - Intervention to the machine construction was done without manufacturer approval
 - Failures were caused by inadequate storing or manipulation
 - Items of common wear such as drive belts, bowdens, filters, plastic washers, blades, etc. are excluded from warranty

The warranty protocol of NTC company can be found at www.ntc.cz or www.ntc.eu

The warranty condition of NTC



NTC STAVEBNÍ TECHNIKA spol. s.r.o.
 Jiřinková 120, 552 03 Česká Skalice
 tel: 491 452 184 fax: 491 401 609
 E-mail: ntc@ntc.cz www.ntc.cz

P-913-5

Warranty protocol

Number:

warranty dept.)

(to be filled by

Failure description (to be filled by machine operator):

Machine type:		Serial number:	
Detailed failure description:			
Is the machine capable of operation?	YES*	NO*	
Date of failure occurring:		Date of failure reporting:	
Machine sale date:		Machine purchased from: NTC / dealer*	Dealer:
Machine owner: (address, phone no., contact person)			
Machine operation site: (if different from owner's address)			

Please send properly filled protocol by fax, e-mail or post to above mentioned address, you will speed the process up!

Accepting the warranty (to be filled in by warranty dept. of NTC):

Date of repair start:		Date of repair finish:	
Internal no:		Signature:	

Claimed failure remedy (to be filled by NTC production dept.):

Way of repairing the failure:	Repair by the user	Repair by NTC	Further way (sending spare parts)
Description of repairing the failure:			
Warranty claim assessment:	YES/NO*	Reason:	
Used spare parts:	Part no.	Description	Pcs

Tech. director sign. : Production director sign:

Finishing warranty management (to be filled by warranty dept. of NTC):

Returning the machine to owner (in case of repair in NTC):	Arranged by:	Way of transport:	Shipment date:
Warranty extension:	Amount of days:	Warranty valid to:	
Warranty solution information to owner:	Date:	Name:	Signature:

Repair costs:		Costs charged to supplier:	
		Final repair costs:	

ОФИЦИАЛЬНЫЙ ДИЛЕР В УКРАИНЕ:

storgom.ua

ГРАФИК РАБОТЫ:

Пн. – Пт.: с 8:30 по 18:30

Сб.: с 09:00 по 16:00

Вс.: с 10:00 по 16:00

КОНТАКТЫ:

+38 (044) 360-46-77

+38 (066) 77-395-77

+38 (097) 77-236-77

+38 (093) 360-46-77

Детальное описание товара: <https://storgom.ua/product/vibroplita-ntc-vdr32.html>

Другие товары: <https://storgom.ua/vibroplity.html>